

2017

porcelain
tile

gres
porcelánico

Mayor
CERÁMICA



INTEGRAL AESTHETICS FOR POOLS AND TERRACES
ESTÉTICA INTEGRAL PARA PISCINA Y TERRAZA

CERÁMICA MAYOR, S.A.
Partida Planet, s/n
03510 Callosa d'En Sarrià
(Alicante-España)

T+34 965 881 175
www.ceramicamayor.com

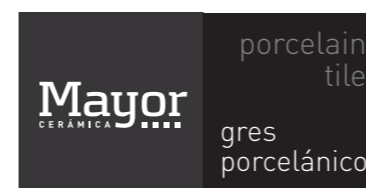

INDEX ÍNDICE

pools

Skimmer System
Sistema Skimmer

10 _ MIKONOS

Overflowing & Skimmer Systems
Sistemas Desbordantes y Skimmer

18 _ MAUI

26 _ VIERTEAGUAS & STEP 33X120

34 _ CANARIAS

Overflowing System
Sistema Desbordante

42 _ HAWAII

52 _ Technical characteristics

56 _ Safety R12

57 _ Public pool solutions

terraces

Collections
Colecciones

60 _ Riverside

66 _ Stromboli

72 _ Rainforest

78 _ Sea Rock

84 _ Colonial

88 _ Canyon

94 _ Fossil

100 _ Materia

106 _ Technical characteristics



Promotional Media
Soportes promocionales
PROMOTIONAL p.114



Packing list
Listado de packing
PACKING p.120



PORCELAIN POOL SYSTEMS

SISTEMAS PORCELÁNICOS PARA PISCINA

10

Reasons to enjoy your pool Razones para disfrutar de tu piscina



1 INTEGRAL AESTHETICS FOR POOL AND TERRACES. A terrace with a single design and forget about having cutting areas between the terrace and pool.

ESTÉTICA INTEGRAL PARA PISCINA Y TERRAZA. Una terraza con un solo diseño 360º y olvídate de tener zonas de corte entre la terraza y la piscina.

WHICH IS THE POOL OF YOUR DREAMS ?. Infinity, lagoon, indoor, wellness, traditional or contemporary. We can do it!

¿CUÁL ES LA PISCINA DE TUS SUEÑOS?. Infinity, laguna, indoor, wellness, tradicionales o contemporáneas. ¡Podemos hacerlo!



2



3 ANTISLIP. Avoid accidents and falls with a material that meets outdoor requirements.

ANTIDESLIZANTE. Evita accidentes y caídas tontas con un material que cumple la normativa obligatoria para exteriores.

LONG LIFE PRODUCT. Porcelain stoneware is a material that does not deteriorate over the years. Build long-term thinking.

PARA TODA LA VIDA. El gres porcelánico es un material que no se deteriora con el paso del tiempo. Construye pensando a largo plazo.

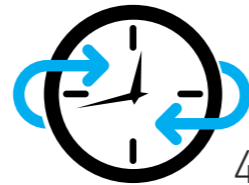

4

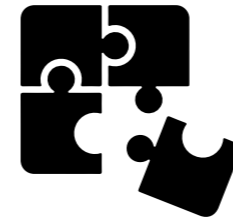

5

INTELLIGENT SYSTEMS, combinable with each other to find the best solution to all types of swimming pools.

SISTEMAS INTELIGENTES, combinables entre si para encontrar la mejor solución constructiva a todo tipo de piscinas.

ATHERMAL FEELING. Do not burn your feet. Our Mikonos & Hawaii systems reduce 30% the heat feeling.

SENSACIÓN TÉRMICA. No te quemes los pies. Nuestros sistemas Mikonos y Hawaii disminuyen un 30% la sensación térmica al contacto.



6



7

CUSTOMIZATION AND WARNING SIGNALING. If your project requires it we can customize or signal our systems by printing.

PERSONALIZACIÓN Y SEÑALIZACIONES DE ADVERTENCIA. Si su proyecto lo requiere podemos personalizar o señalar nuestros sistemas mediante impresión.

IDEAL FOR REHABILITATIONS. It easily adapts to existing swimming pools due to its standard dimensions.

IDEAL PARA REHABILITACIONES. Se acopla fácilmente a piscinas ya existentes gracias a sus dimensiones estándar.



8



9

RESISTANT SPECIAL POOL CHEMICALS. Material that does not stain or alter with the additives they put into the pool water for maintenance.

RESISTENTE A PRODUCTOS QUÍMICOS PARA PISCINAS. Material que no se mancha ni altera con los aditivos que se le ponen al agua de la piscina para su mantenimiento.

EASY MAINTENANCE. Material easy to clean with hose or kartcher. Invest time in enjoying life.

FÁCIL MANTENIMIENTO. Material de fácil limpieza con manguera o kartcher e invierte el tiempo en disfrutar.

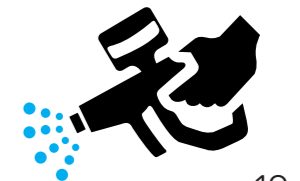

10



INTEGRAL AESTHETICS
FOR POOLS & TERRACES



LONG LIFE PRODUCTS



SAFETY SYSTEMS



Terrace Solutions
Soluciones de terraza



One piece for each solutions

Una pieza para cada solución



Curve systems
Sistemas curvos

Pools systems in combination with our terrace series

Sistemas de piscina en combinación con nuestras series de terraza



INTEGRAL AESTHETICS
For Pools and Terraces



MIKONOS

SKIMMER SYSTEM
SISTEMA SKIMMER



MIKONOS

BASIC SYSTEM PIECES SISTEMA BÁSICO DE PIEZAS



-30% Sensación térmica
Thermal feeling

2 SIDES PAINTED PINTADO A DOS CARAS

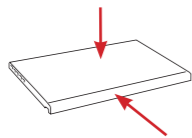

MIKONOS EDGE - BORDE MIKONOS
Ref. BPMI 0000 E2C 45x70 **(M-517) pz**
MONOBLOCK

3 SIDES PAINTED PINTADO A TRES CARAS

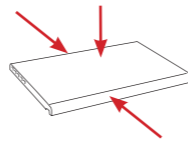

MIKONOS EDGE - BORDE MIKONOS
Ref. BPMI 0000 E3C 45x70 **(M-525) pz**
MONOBLOCK

Dimensions

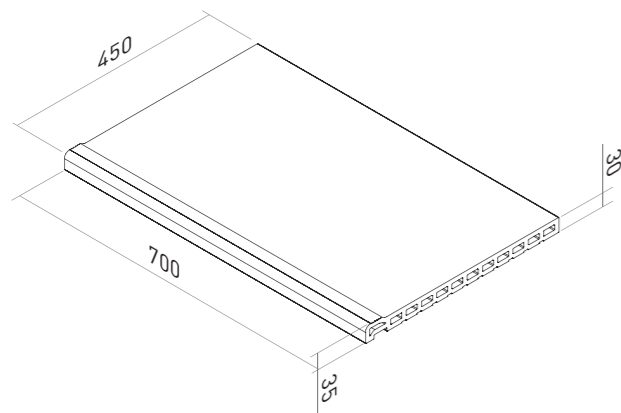

Special piece with hole for skimmer Pieza especial para skimmer



●● Ref. BPMI SK00 E2C 45x70 (skimmer) **(M-530) pz**
●●● Ref. BPMI SK00 E3C 45x70 (skimmer) **(M-736) pz**

MIKONOS DETAIL DETALLE MIKONOS



DETAIL SYSTEM DETALLE SISTEMA

- 1_ MIKONOS EDGE WITH SKIMMER HOLE
BORDE MIKONOS CON AGUJERO SKIMMER
- 2_ 22,5x75 TILE
22,5x75 BASE
- 3_ MIKONOS EDGE
BORDE MIKONOS
- 4_ TILE
BASE

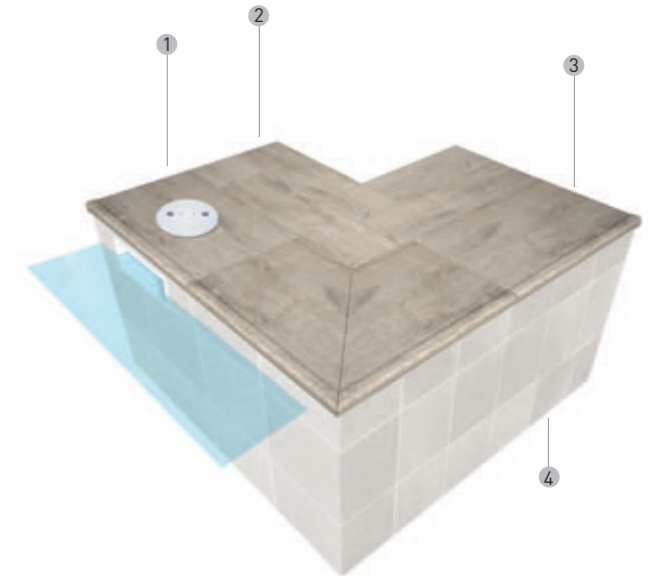

TECHNICAL INFORMATION INFORMACIÓN TÉCNICA

R12 Super antislip
Súper antideslizante

-30% Sensación térmica
Thermal feeling

UNE ENV 12633
Clase 3

DIN 51130
R12

DIN 51097
Clase C

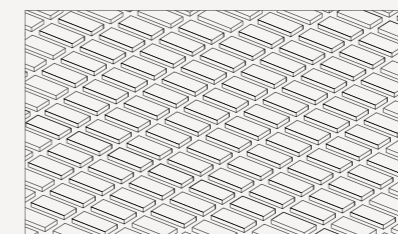

Chemical resistance
Resistencia química

Frost resistance
Resistencia a la helada

Long life product
Producto de larga vida

Easy maintenance
Fácil mantenimiento

Integral aesthetics
Estética integral

CORNER SOLUTION
SOLUCIÓN ESQUINA

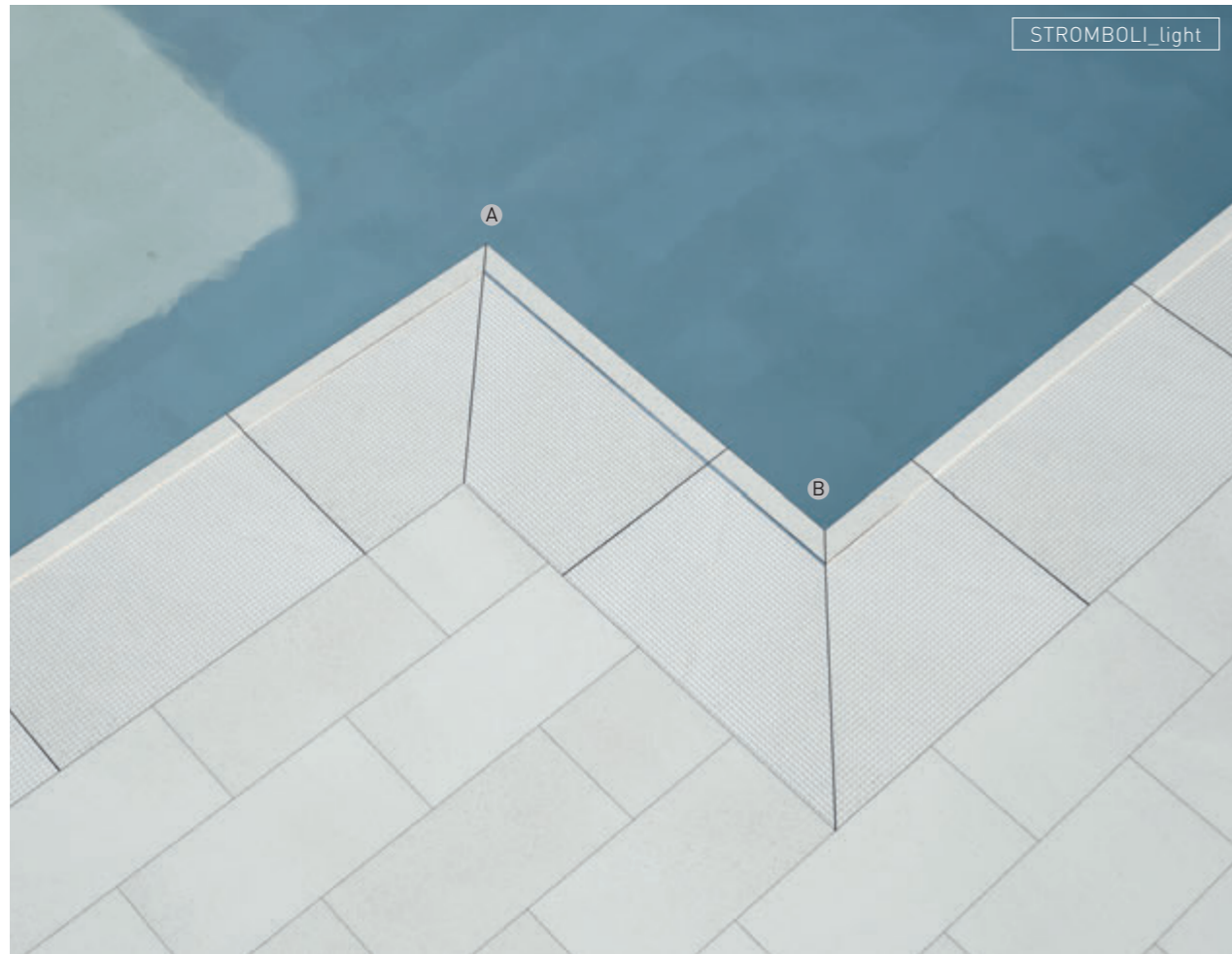

STROMBOLI_light



A CORNER SOLUTION
SOLUCIÓN ESQUINA
Ref. BPMI EE00 E2C 45x70 **(M-567) 2pz** ♦♦
Ref. BPMI EE00 E3C 45x70 **(M-579) 2pz** ♦♦♦



CORNER SOLUTION B
SOLUCIÓN ESQUINA
Ref. BPMI EI00 E2C 45x70 **(M-567) 2pz** ♦♦
Ref. BPMI EI00 E3C 45x70 **(M-579) 2pz** ♦♦♦

CURVE SOLUTION
SOLUCIÓN CURVA



STROMBOLI_light



A MIKONOS CURVED POOL EDGE
BORDE CURVO MIKONOS
Ref. BPMI RI00 E2C 45x- **(M-737) pz** ♦♦
Ref. BPMI RI00 E3C 45x- **(M-738) pz** ♦♦♦



MIKONOS CURVED POOL EDGE B
BORDE CURVO MIKONOS
Ref. BPMI RE00 E2C 45x- **(M-737) pz** ♦♦
Ref. BPMI RE00 E3C 45x- **(M-738) pz** ♦♦♦

RADIUS: 1.06m / 2.00m / 3.00m / 4.00m / 5.00m / +5.00m

Special Projects, consult factory. Extra cost Ref. 6624 (M-600) pz
Proyectos especiales consultar con fábrica. Coste extra Ref. 6624 (M-600) pz



MAUI

OVERFLOWING & SKIMMER SYSTEM
SISTEMA DESBORDANTE Y SKIMMER

STROMBOLI_light



MAUI

BASIC SYSTEM PIECES SISTEMA BÁSICO DE PIEZAS

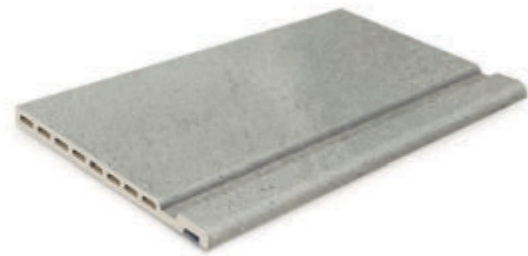

Ref.

Características

MAUI EDGE
BORDE MAUI
Ref. BPMA 0000 33x50 **(M-746) pz**
MONOBLOCK

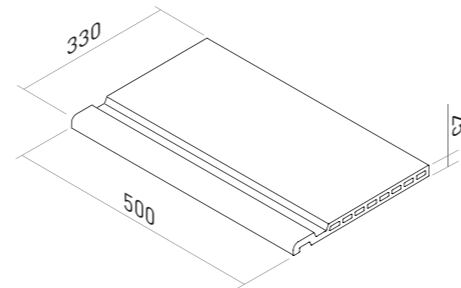

CERAMIC GRATE
REJILLA CERÁMICA
Ref. RJ66 0000 25x50 **(M-747) pz**
MONOBLOCK

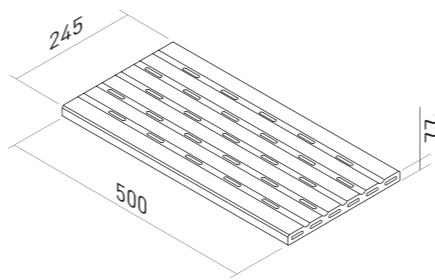

Component: Grate Rubber
Componente: Goma p/Rejilla
Art. 6491 **(M-250) ml**

Breaking Load
Fuerza de rotura **>3500N** EN ISO 10545-4

Drain
Desagüe **> 19.7 m³/hora**

TECHNICAL INFORMATION INFORMACIÓN TÉCNICA

UNE ENV 12633
Clase 3

DIN 51130
R10

DIN 51097
Clase C

Noiseless
Silencioso

Comfortable
Cómodo

Safety, without blind spots
Seguro, sin puntos ciegos

Chemical resistance
Resistencia química

Frost resistance
Resistencia a la helada

Long life product
Producto de larga vida

Easy maintenance
Fácil mantenimiento

Integral aesthetics
Estética integral



SKIMMER SYSTEM DETAIL DETALLE SISTEMA SKIMMER

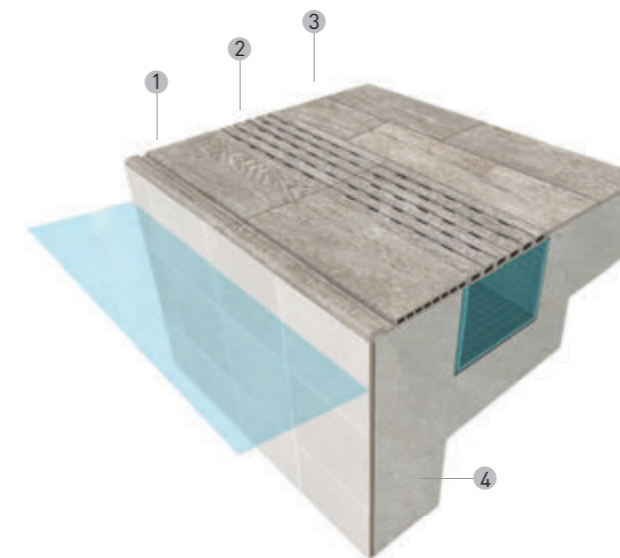

OVERFLOWING SYSTEM DETAIL DETALLE SISTEMA DESBORDANTE

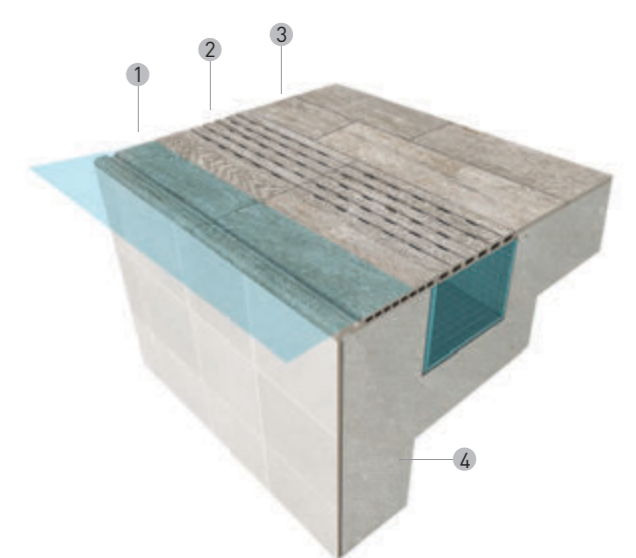

- 1_ MAUI GRATE EDGE-SUPPORT
BORDE MAUI P/REJILLA
- 2_ CERAMIC GRATE RJ66 0000
REJILLA CERÁMICA RJ66 0000
- 3_ TILES
BASE
- 4_ CONCRETE
HORMIGÓN

CORNER SOLUTION
SOLUCIÓN ESQUINA



STROMBOLI_light

STROMBOLI_light

B

A



Maui

25

24 Mayor



A

CERAMIC GRATE CORNER PACK
PACK ESQUINA REJILLA CERÁMICA
Ref. RJ66 E000 25x50 **(M-749) 2pz**

MAUI EDGE CORNER PACK
PACK EQUINA BORDE MAUI
Ref. BPMA EI00 33x50 **(M-748) 2pz**

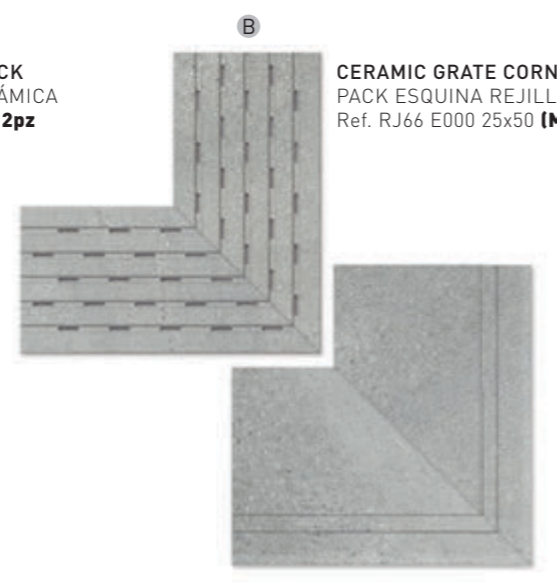

B

CERAMIC GRATE CORNER PACK
PACK ESQUINA REJILLA CERÁMICA
Ref. RJ66 E000 25x50 **(M-749) 2pz**

MAUI EDGE CORNER PACK
PACK EQUINA BORDE MAUI
Ref. BPMA EE00 33x50 **(M-748) 2pz**

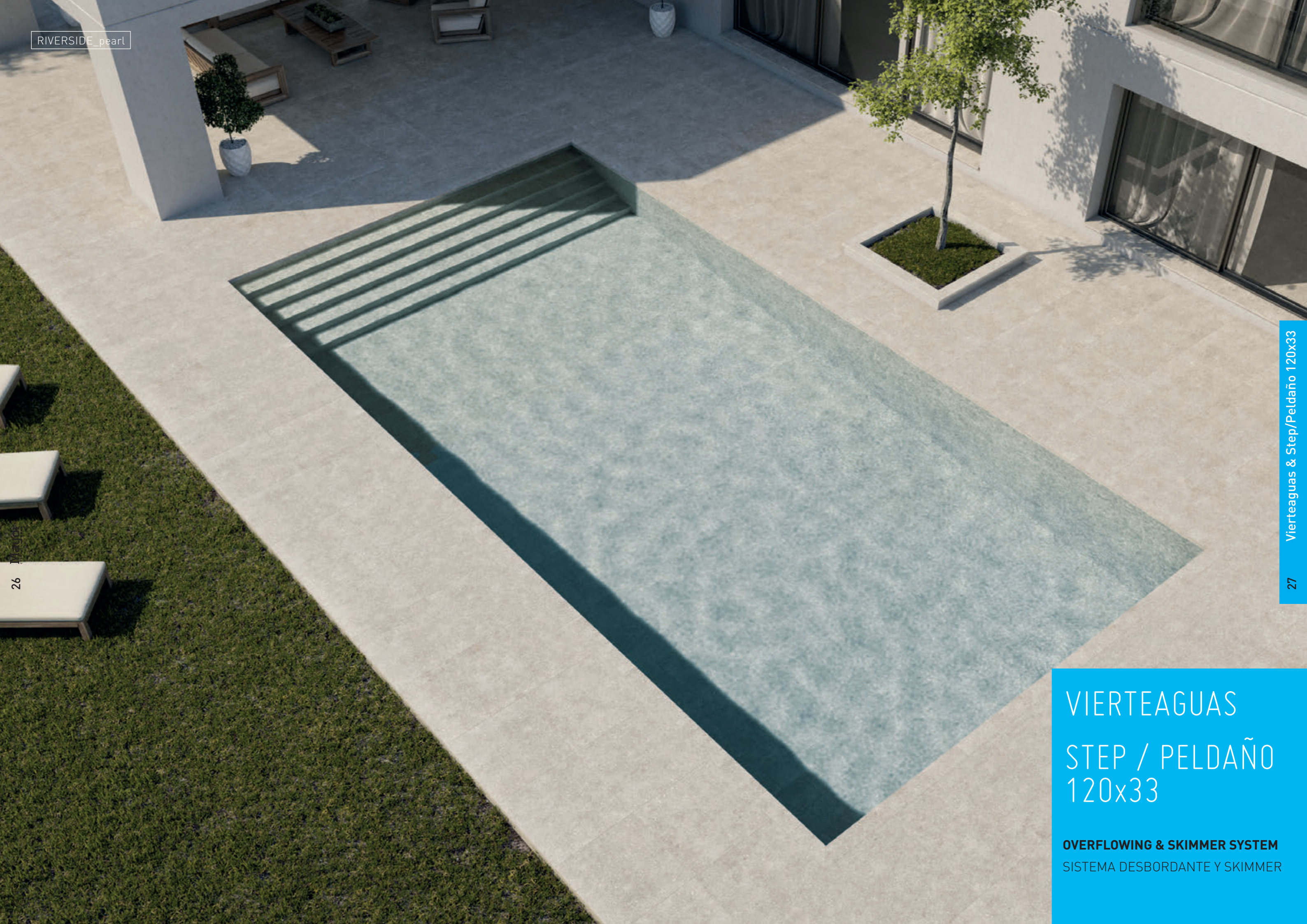

VIERTEAGUAS STEP / PELDAÑO 120x33

OVERFLOWING & SKIMMER SYSTEM
SISTEMA DESBORDANTE Y SKIMMER



'VIERTEAGUAS' COPING

CORONACIÓN CON VIERTEAGUAS



'Vierteaguas'
MONOBLOCK
18x50 cm (M-392) pz

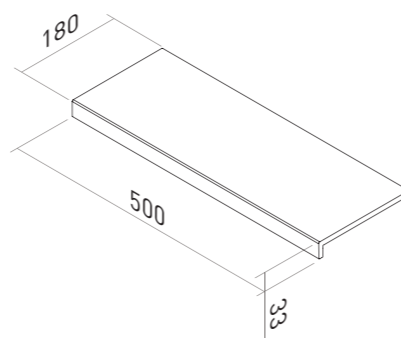

A 'Vierteaguas' corner pack
Pack esquina vierteaguas
Ref. VIER EE00 18x50 (M-735) 2 pzs



B 'Vierteaguas' corner pack
Pack esquina vierteaguas
Ref. VIER EI00 18x50 (M-735) 2 pzs

Special Projects, consult factory. Extra cost Ref. 6624 (M-600) pz
Proyectos especiales consultar con fábrica. Coste extra Ref. 6624 (M-600) pz

POOL EDGE SOLUTION SOLUCIÓN BORDE PISCINA

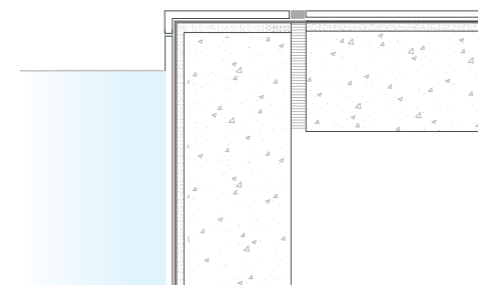

MULTIFUNCTION PIECE
PIEZA MULTIFUNCIÓN

IDEAL FOR PLANTERS
IDEAL PARA JARDINERAS

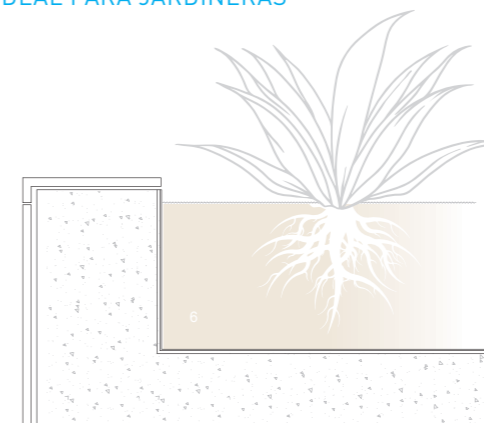

INFINITY POOL SOLUTION SOLUCIÓN PISCINA INFINITY

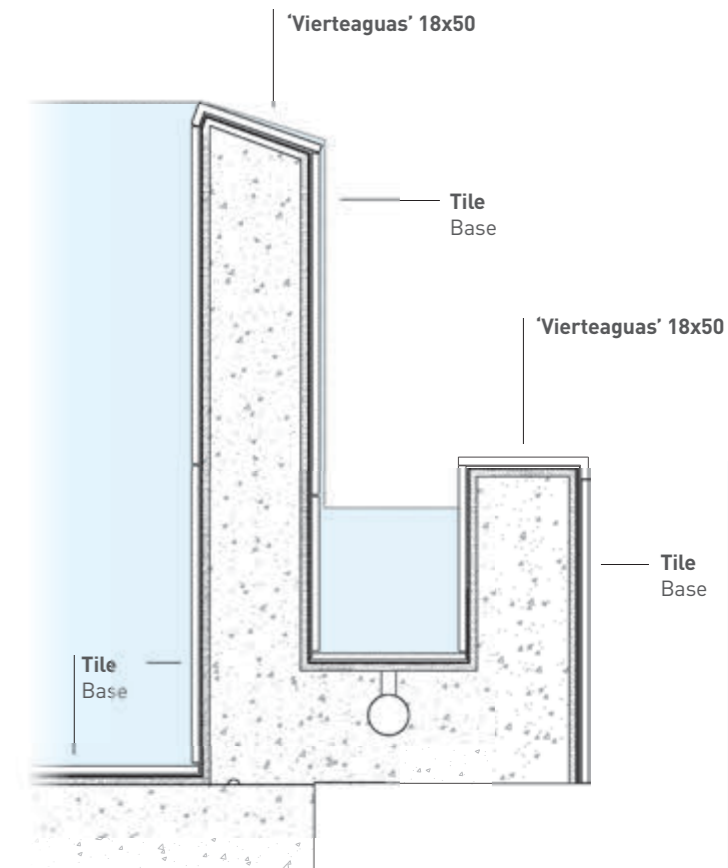

TECHNICAL INFORMATION INFORMACIÓN TÉCNICA

UNE ENV 12633
Clase 3

DIN 51130
R10

DIN 51097
Clase C

Noiseless
Silencioso

Comfortable
Cómodo

Safety, without blind spots
Seguro, sin puntos ciegos

Chemical resistance
Resistencia química

Frost resistance
Resistencia a la helada

Long life product
Producto de larga vida

Easy maintenance
Fácil mantenimiento

Integral aesthetics
Estética integral

MULTIFUNCTION PIECE
PIEZA MULTIFUNCIÓN

Pool Edge
Borde de piscina

Terrace Solutions
Soluciones para Terraza

Inside Pool Solutions
Soluciones para interior de la piscina

120x33 STEP COPING

CORONACIÓN CON PELDAÑO 120x33



Complete step
Peldaño completo
MONOBLOCK
120x33 (M-419) pz

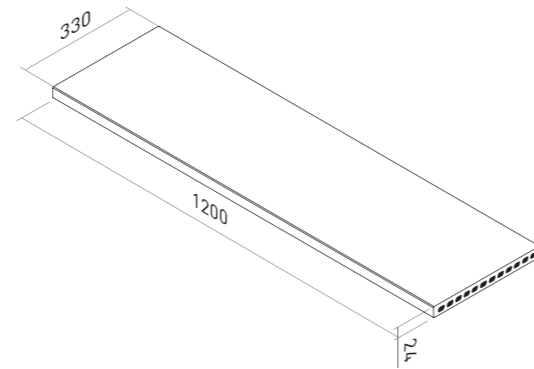

INSIDE POOL SOLUTION

SOLUCIÓN PARA EL INTERIOR DE LA PISCINA



SEA ROCK_caramel

COPING SOLUTION

SOLUCIÓN PARA CORONACIÓN DE PISCINA



RAINFOREST_musgo

SKIMMER SYSTEM

SISTEMA SKIMMER

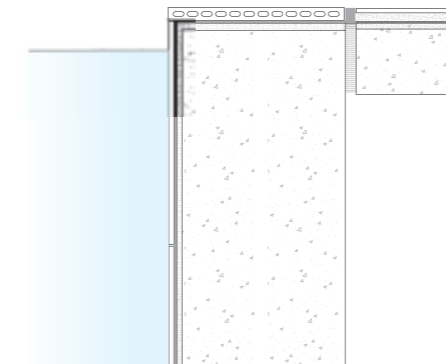

OVERFLOWING SYSTEM

SISTEMA DESBORDANTE

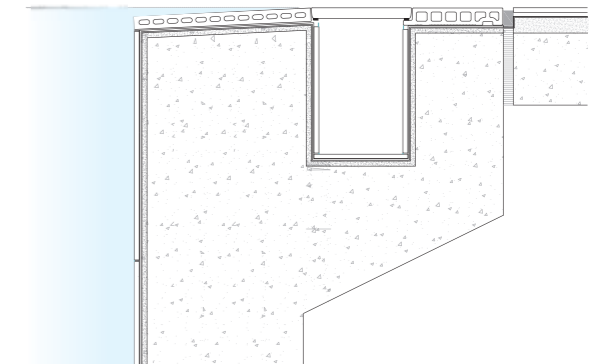

TECHNICAL INFORMATION

INFORMACIÓN TÉCNICA

UNE ENV 12633
Clase 3

DIN 51130
R10

DIN 51097
Clase C

Noiseless
Silencioso

Comfortable
CÓMODO

Safety, without blind spots
Seguro, sin puntos ciegos

Chemical resistance
Resistencia química

Frost resistance
Resistencia a la helada

Long life product
Producto de larga vida

Easy maintenance
Fácil mantenimiento

Integral aesthetics
Estética integral

MULTIFUNCTION PIECE
PIEZA MULTIFUNCIÓN

Pool Edge
Borde de piscina

Terrace Solutions
Soluciones para Terraza

Inside Pool Solutions
Soluciones para interior de la piscina



CANARIAS

OVERFLOWING & SKIMMER SYSTEM
SISTEMA DESBORDANTE Y SKIMMER



CANARIAS

BASIC SYSTEM PIECES SISTEMA BÁSICO DE PIEZAS

RAINFOREST_blanco



Ref.

Características

CANARIAS GRATE EDGE-SUPPORT
BORDE-SOPORTE CANARIAS P/REJILLA
Ref. BSCA 0000 18x50 **(M-729) pz**
MONOBLOCK

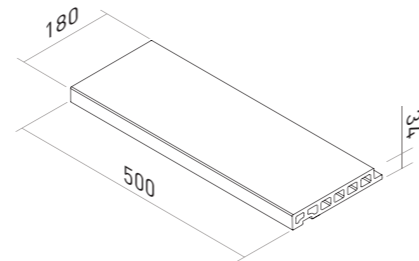

CERAMIC GRATE
REJILLA CERÁMICA
Ref. RJ70 0000 20x50 **(M-731) pz**
MONOBLOCK

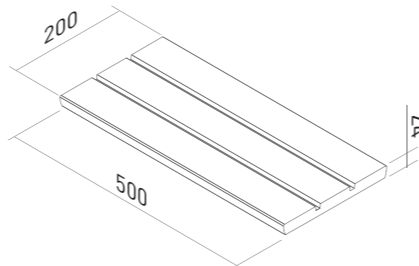

Component: Grate Rubber
Componente: Goma p/Rejilla
Art. 6491 **(M-250) ml**

Breaking Load
Fuerza de rotura **>4000N**
EN ISO 10545-4

Drain
Desagüe **> 9.7 m³/hora**

CANARIAS GRATE EDGE-SUPPORT
BORDE-SOPORTE CANARIAS P/REJILLA
Ref. BSCA 0000 18x50 **(M-729) pz**
MONOBLOCK

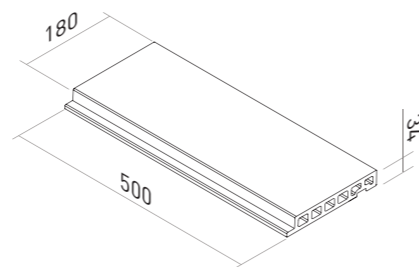

TECHNICAL INFORMATION INFORMACIÓN TÉCNICA

UNE ENV 12633
Clase 3

DIN 51130
R10

DIN 51097
Clase C

Noiseless
Silencioso

Comfortable
Cómodo

Safety, without blind spots
Seguro, sin puntos ciegos

Chemical resistance
Resistencia química

Frost resistance
Resistencia a la helada

Long life product
Producto de larga vida

Easy maintenance
Fácil mantenimiento

Integral aesthetics
Estética integral

MULTIFUNCTION PIECE
PIEZA MULTIFUNCIÓN

Pool Edge
Borde de piscina

Terrace Solutions
Soluciones para Terraza

Inside Pool Solutions
Soluciones para interior
de la piscina

CANARIAS DETAIL DETALLE CANARIAS



SKIMMER SYSTEM DETAIL DETALLE SISTEMA SKIMMER

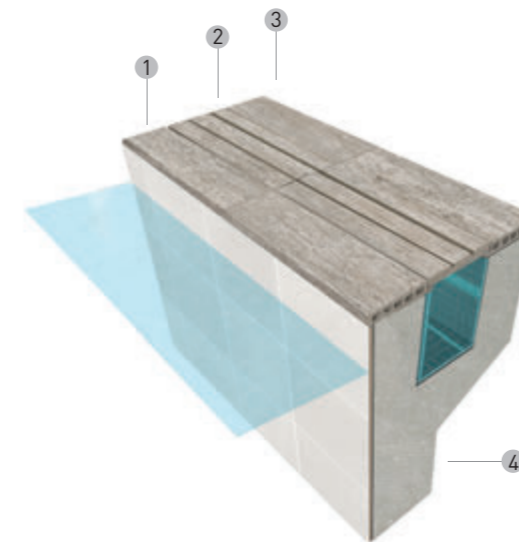

OVERFLOWING SYSTEM DETAIL DETALLE SISTEMA DESBORDANTE

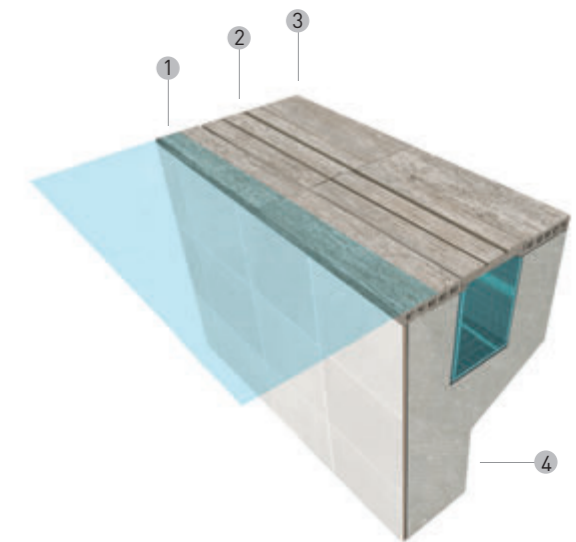

- 1_ CANARIAS GRATE EDGE-SUPPORT
BORDE-SOPORTE CANARIAS P/REJILLA
- 2_ CERAMIC GRATE RJ70 0000
REJILLA CERÁMICA RJ70 0000
- 3_ CANARIAS GRATE EDGE-SUPPORT
BORDE-SOPORTE CANARIAS P/REJILLA
- 4_ CONCRETE
HORMIGÓN

CORNER SOLUTION SOLUCIÓN ESQUINA

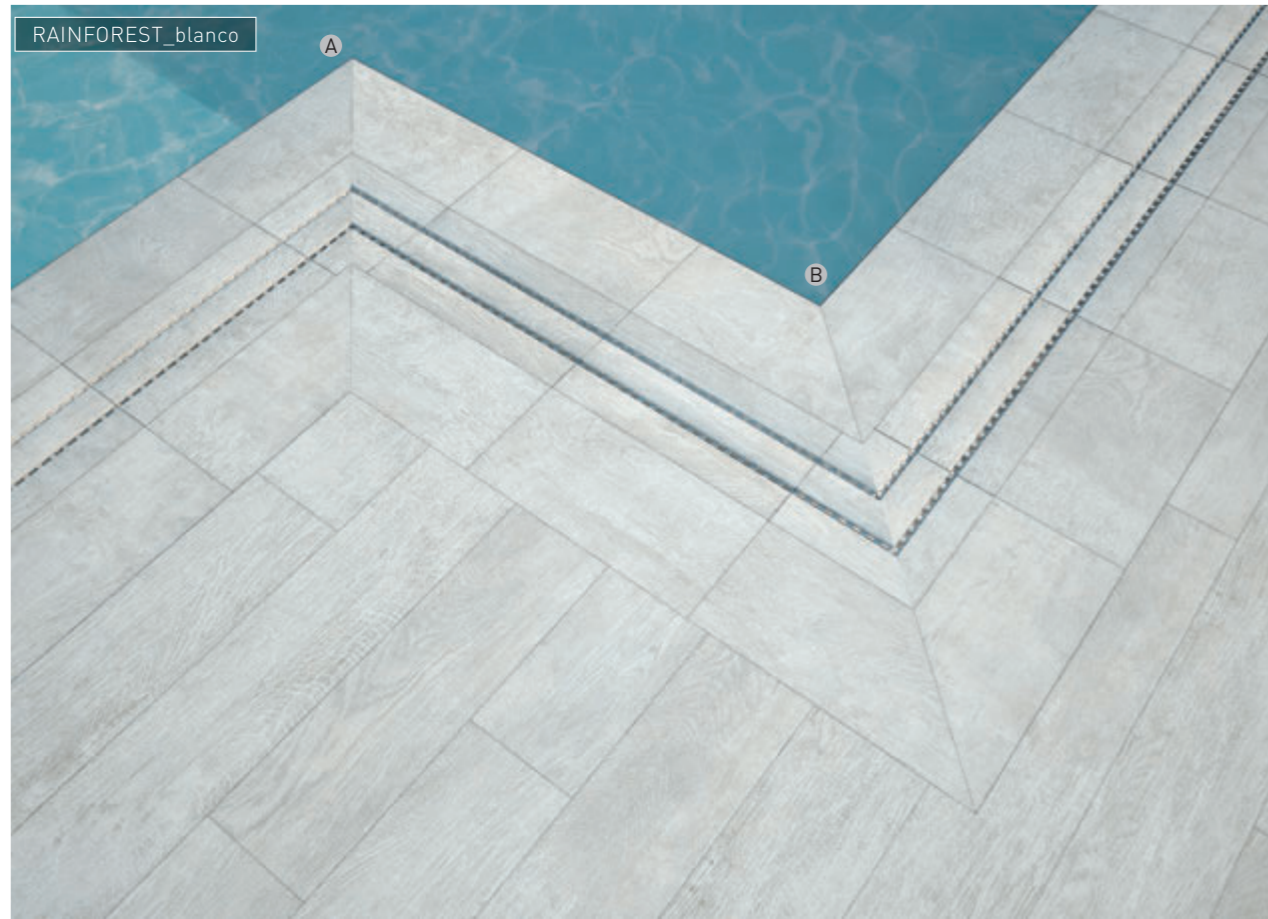

CURVE SOLUTION SOLUCIÓN CURVA

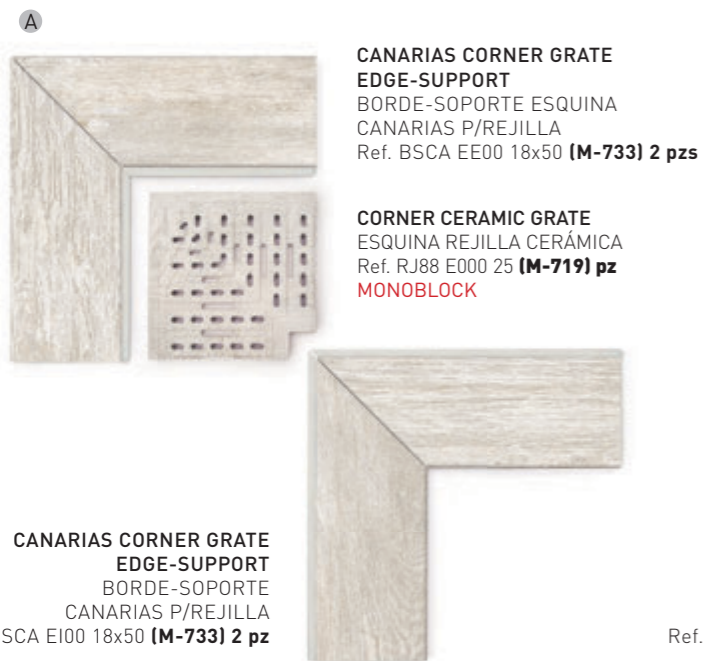

En la solución de este sistema se pueden usar dos tipos de rejilla RJ88 y RJ70

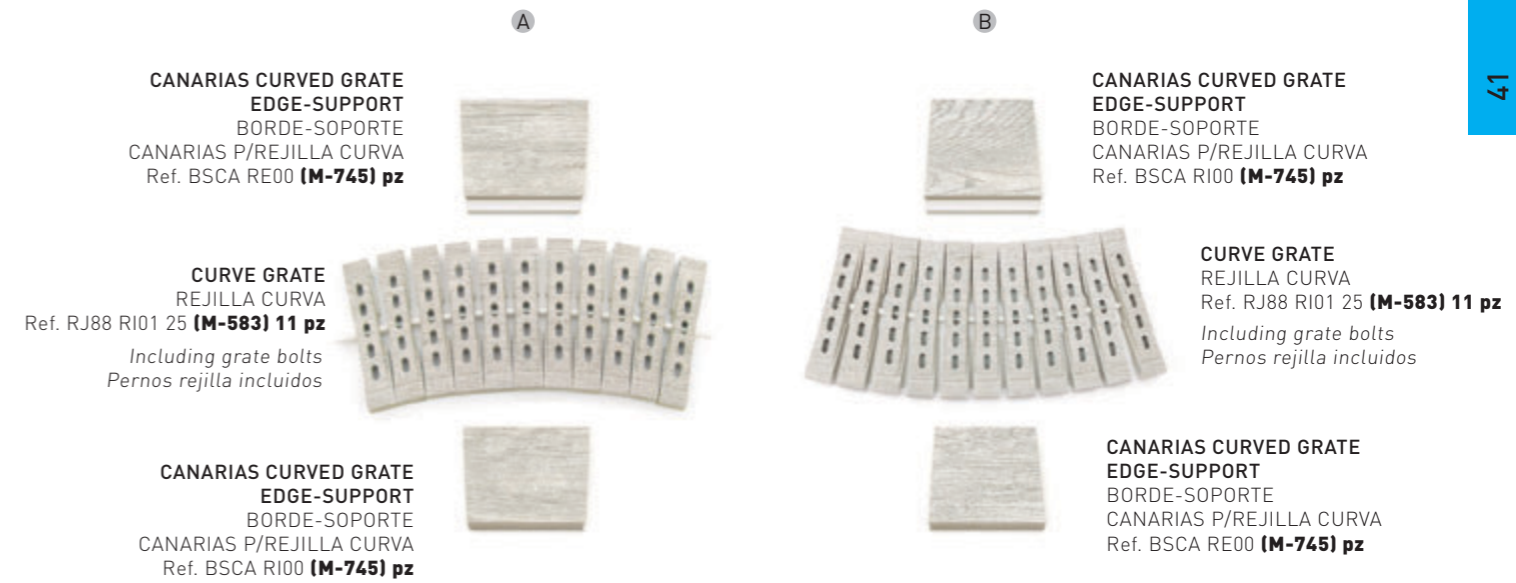

RADIOUS: 1.06m / 2.00m / 3.00m / 4.00m / 5.00m / +5.00m

Special Projects, consult factory. Extra cost Ref. 6624 **(M-600) pz**
Proyectos especiales consultar con fábrica. Coste extra Ref. 6624 **(M-600) pz**



Grate bolts
Pernos rejilla
Art. 6493 **(M-704) 25 pz**

STROMBOLI_light



HAWAII

OVERFLOWING SYSTEM
SISTEMA DESBORDANTE





HAWAII

BASIC SYSTEM PIECES SISTEMA BÁSICO DE PIEZAS

SERIE: SEA ROCK_caramel



Ref.

Características

HAWAII EDGE
BORDE HAWAII
Ref. BPHA 0000 25x50 (M-709) pz
MONOBLOCK



R12 Super antislip
Súper antideslizante

-30% Sensación térmica
Thermal feeling

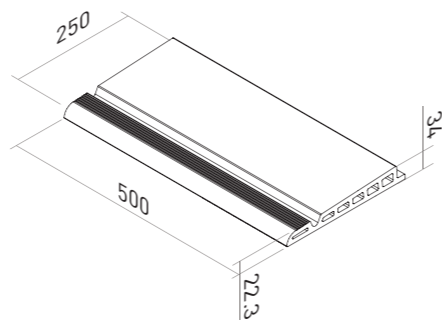

OVERFLOWING >>5%

CERAMIC GRATE
REJILLA CERÁMICA
Ref. RJ88 0000 25x50 (M-516) pz
MONOBLOCK

Worldwide Patent
Patente Mundial



Grate Rubber
Goma p/Rejilla
Art. 6491 (M-250) ml

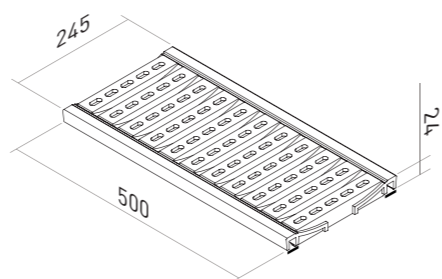

Breaking Load
Fuerza de rotura

EN ISO 10545-4
>3500N

Drain
Desagüe

> 57 m³/hora

HAWAII GRATE SUPPORT
SOPORTE HAWAII P/REJILLA
Ref. SRHA 0000 18x50 (M-716) pz
MONOBLOCK



R12 Super antislip
Súper antideslizante

-30% Sensación térmica
Thermal feeling

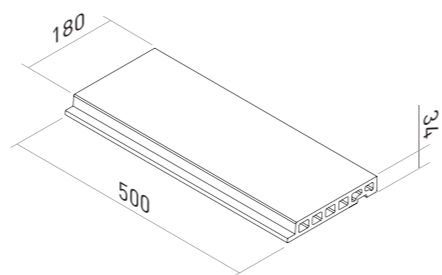

HAWAII DETAIL DETALLE HAWAII

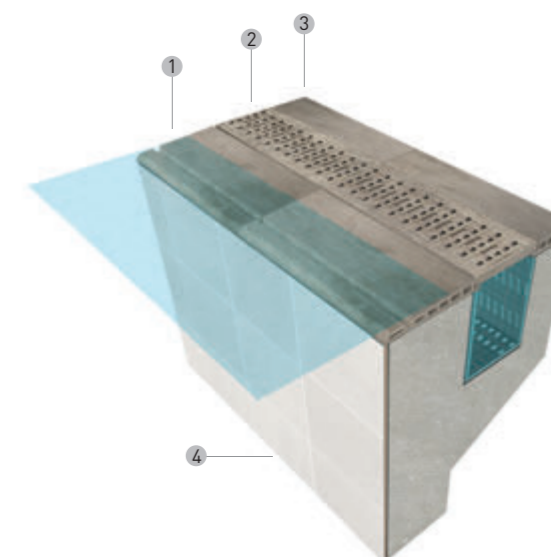

- 1_ HAWAII EDGE
BORDE HAWAII
- 2_ CERAMIC GRATE RJ88 0000
REJILLA CERÁMICA RJ88 0000
- 3_ HAWAII GRATE SUPPORT
SOPORTE REJILLA HAWAII
- 4_ TILE
BASE

TECHNICAL INFORMATION INFORMACIÓN TÉCNICA

R12 Super antislip
Súper antideslizante

UNE ENV 12633
Clase 3

DIN 51130
R12

DIN 51097
Clase C

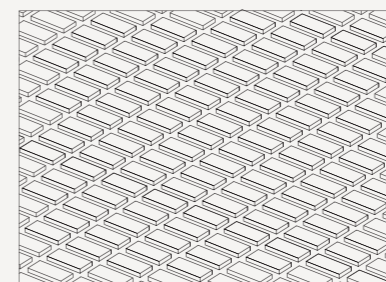

-30% Sensación térmica -30%
Thermal feeling -30%

Noiseless
Silencioso

Comfortable
Cómodo

Safety, without blind spots
Seguro, sin puntos ciegos

Chemical resistance
Resistencia química

Frost resistance
Resistencia a la helada

Long life product
Producto de larga vida

Easy maintenance
Fácil mantenimiento

Integral aesthetics
Estética integral

CORNER SOLUTION SOLUCIÓN ESQUINA



CURVE SOLUTION SOLUCIÓN CURVA



En la solución de este sistema se pueden usar dos tipos de rejilla RJ88 y RJ70

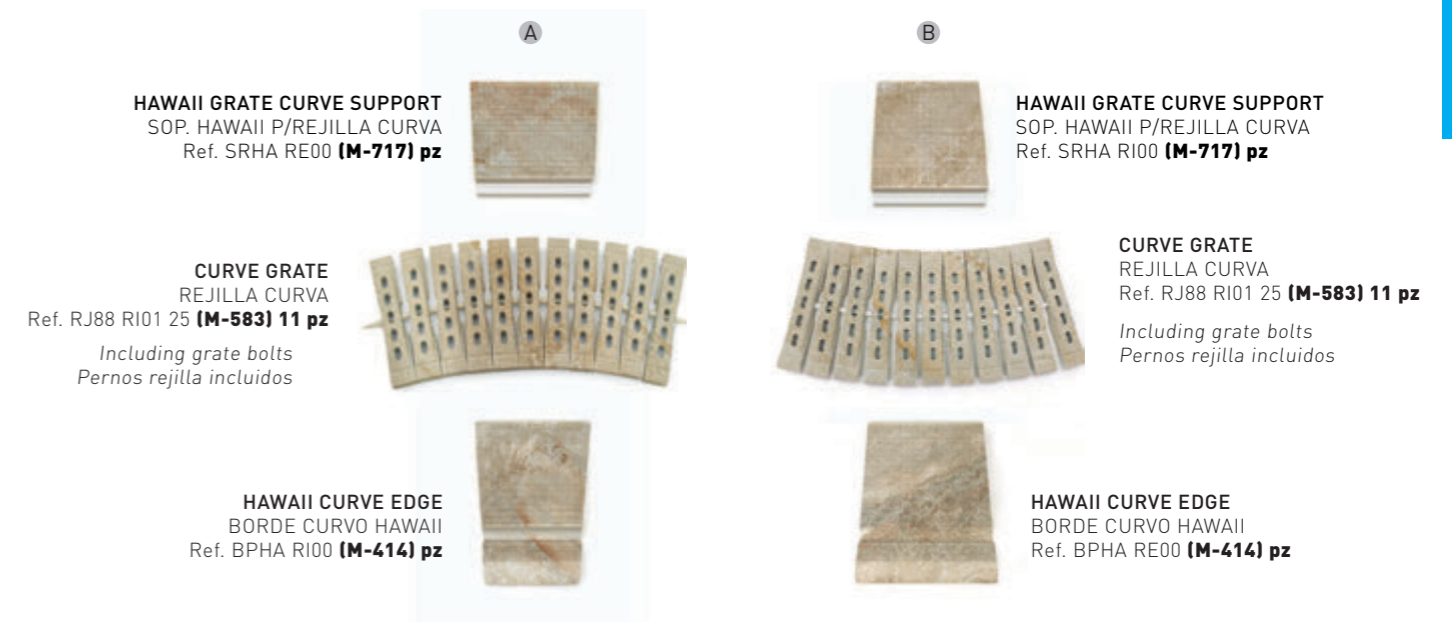

RADIOUS: 1.06m / 2.00m / 3.00m / 4.00m / 5.00m / +5.00m
Special Projects, consult factory. Extra cost Ref. 6624 (M-600) pz
Proyectos especiales consultar con fábrica. Coste extra Ref. 6624 (M-600) pz



Grate bolts
Pernos rejilla
Art. 6493 (M-704) 25 pz

CERAMIC GRATE INFORMATION

INFORMACIÓN SOBRE LAS REJILLAS CERÁMICAS

Grate rubber installation

Instalación de la goma de rejilla

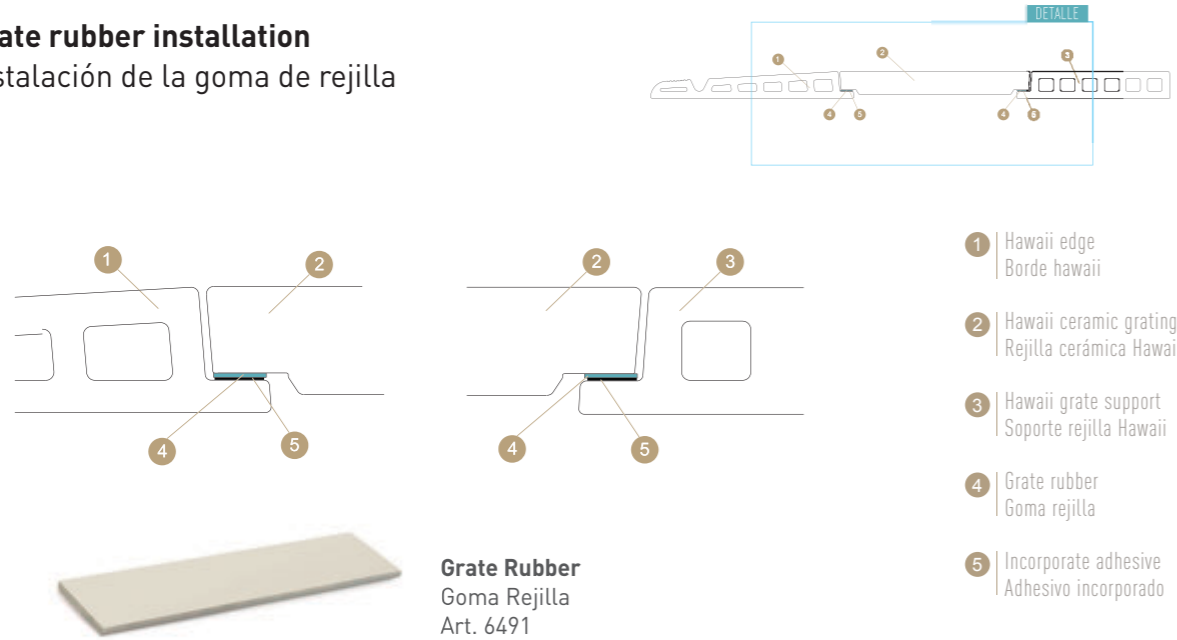

Ceramic Grate

Rejilla Cerámica

RJ70 0000
20 x 50 cm

- Antideslizante Antislip | UNE ENV 12633 **Clase 3**
- Antideslizante Antislip | DIN 51130 **R10**
- Antideslizante Antislip | DIN 51097 **Clase C**
- Resistencia al impacto Impact strength | EN ISO 10545-5 ✓
- Resistencia a las manchas Stain resistance | EN ISO 10545-14 **5**
- Resistencia al rayado Scratch resistance | UNE 67101 **9**
- Chemical resistance Resistencia química | EN ISO 10545-13 **GA / GLA / GHA**
- Resistencia a la abrasión Friction resistance | EN ISO 10545-7 **IV - V**
- Absorción de agua Water absorption | EN ISO 10545-3 **< 0,5 %**
- Resistencia a la helada Frost resistance | EN ISO 10545-12 ✓
- Resistencia al choque térmico Thermal shock resistance | EN ISO 10545-9 ✓
- Fuerza de rotura Breaking Load | EN ISO 10545-4 **>4000N**
- Drain Desagüe | **> 9.7 m³/hora**
- Tolerancia dimensional Dimensional tolerance | EN ISO 10545-2 ✓
- Fire resistance Resistencia al fuego | **CLASE A1n** ✓

Ceramic Grate

Rejilla Cerámica

RJ88 0000
25 x 50 cm

- Antideslizante Antislip | UNE ENV 12633 **Clase 3**
- Antideslizante Antislip | DIN 51130 **R12**
- Antideslizante Antislip | DIN 51097 **Clase C**
- Resistencia al impacto Impact strength | EN ISO 10545-5 ✓
- Resistencia a las manchas Stain resistance | EN ISO 10545-14 **5**
- Resistencia al rayado Scratch resistance | UNE 67101 **9**
- Chemical resistance Resistencia química | EN ISO 10545-13 **GA / GLA / GHA**
- Resistencia a la abrasión Friction resistance | EN ISO 10545-7 **IV - V**
- Absorción de agua Water absorption | EN ISO 10545-3 **< 0,5 %**
- Resistencia a la helada Frost resistance | EN ISO 10545-12 ✓
- Resistencia al choque térmico Thermal shock resistance | EN ISO 10545-9 ✓
- Fuerza de rotura Breaking Load | EN ISO 10545-4 **>3500N**
- Drain Desagüe | **> 57 m³/hora**
- Tolerancia dimensional Dimensional tolerance | EN ISO 10545-2 ✓
- Fire resistance Resistencia al fuego | **CLASE A1n** ✓

Ceramic Grate

Rejilla Cerámica

RJ66 0000
25 x 50 cm

- Antideslizante Antislip | UNE ENV 12633 **Clase 3**
- Antideslizante Antislip | DIN 51130 **R10**
- Antideslizante Antislip | DIN 51097 **Clase C**
- Resistencia al impacto Impact strength | EN ISO 10545-5 ✓
- Resistencia a las manchas Stain resistance | EN ISO 10545-14 **5**
- Resistencia al rayado Scratch resistance | UNE 67101 **9**
- Chemical resistance Resistencia química | EN ISO 10545-13 **GA / GLA / GHA**
- Resistencia a la abrasión Friction resistance | EN ISO 10545-7 **IV - V**
- Absorción de agua Water absorption | EN ISO 10545-3 **< 0,5 %**
- Resistencia a la helada Frost resistance | EN ISO 10545-12 ✓
- Resistencia al choque térmico Thermal shock resistance | EN ISO 10545-9 ✓
- Fuerza de rotura Breaking Load | EN ISO 10545-4 **>3500N**
- Drain Desagüe | **> 19.7 m³/hora**
- Tolerancia dimensional Dimensional tolerance | EN ISO 10545-2 ✓
- Fire resistance Resistencia al fuego | **CLASE A1n** ✓

COMPONENTS FOR CURVED POOLS

COMPONENTES PARA PISCINAS CURVAS

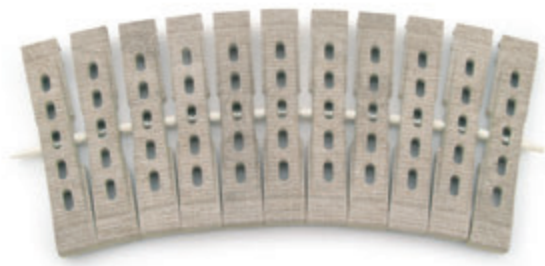

CURVE GRATE (11 pieces)
REJILLA CURVA (11 piezas)
 Ref. RJ88 RI01 25 **(M-583) 11 pz**



Including grate
Pernos rejilla
Art. 6493 (M-704) 25 pz

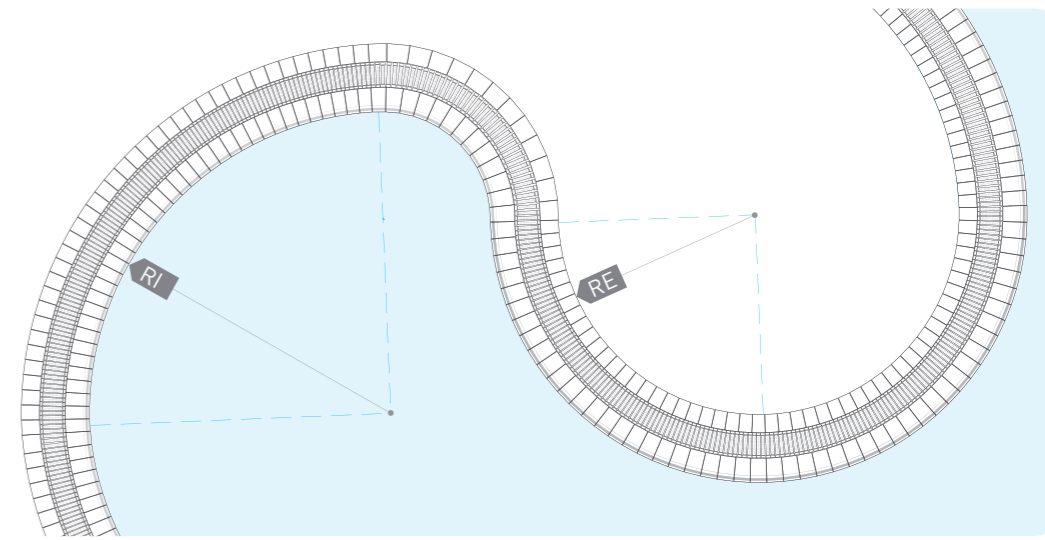

Half circle = 129 pieces
 1/2 curva = 129 piezas

Half circle = 103 pieces
 1/2 curva = 103 piezas

Half circle = 77 pieces
 1/2 curva = 77 piezas

Half circle = 31 pieces
 1/2 curva = 31 piezas

Half circle = 25 pieces
 1/2 curva = 25 piezas

Mesured parts / Piezas a medida

Radius / Radio ≥ 5.00 m
Fixed width / Ancho fijo 12 cm

Radius / Radio 4.00 m

Radius / Radio 3.00 m

Radius / Radio 2.00 m

Radius / Radio 1.06 m

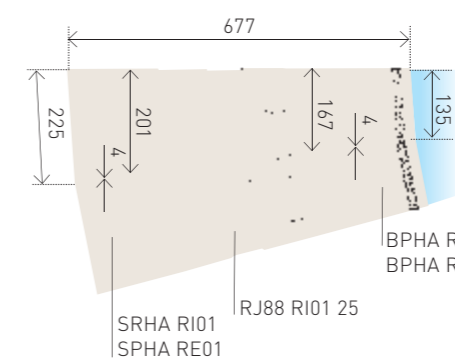
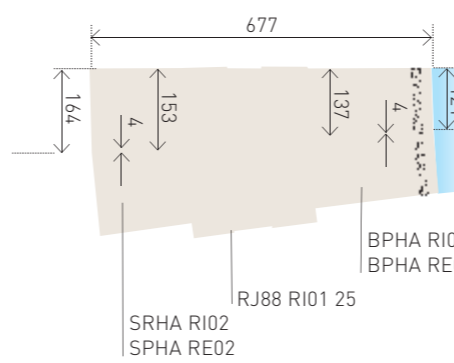
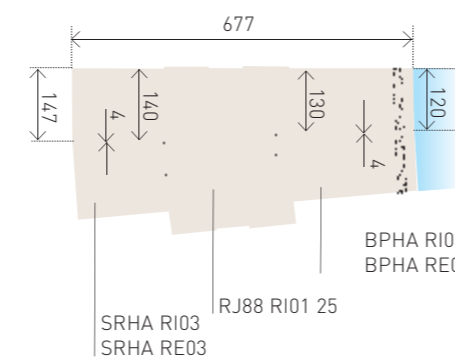
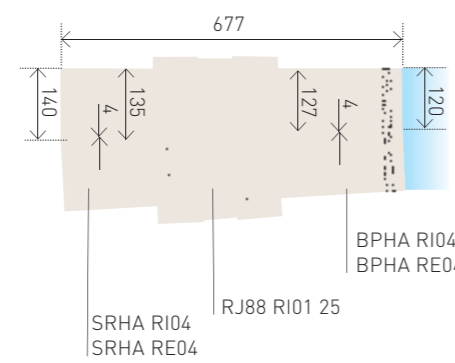
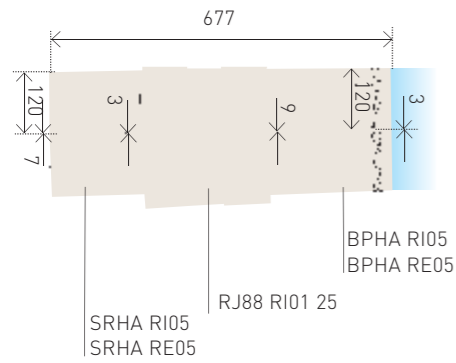

RJ88 RI00 grate mounting

Instalación de la rejilla RJ88 RI00

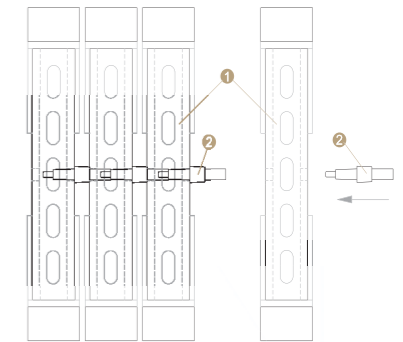

- 1 Curve grate piece
Pieza para rejilla curva
- 2 Bolt for curve Grate
Perno de unión

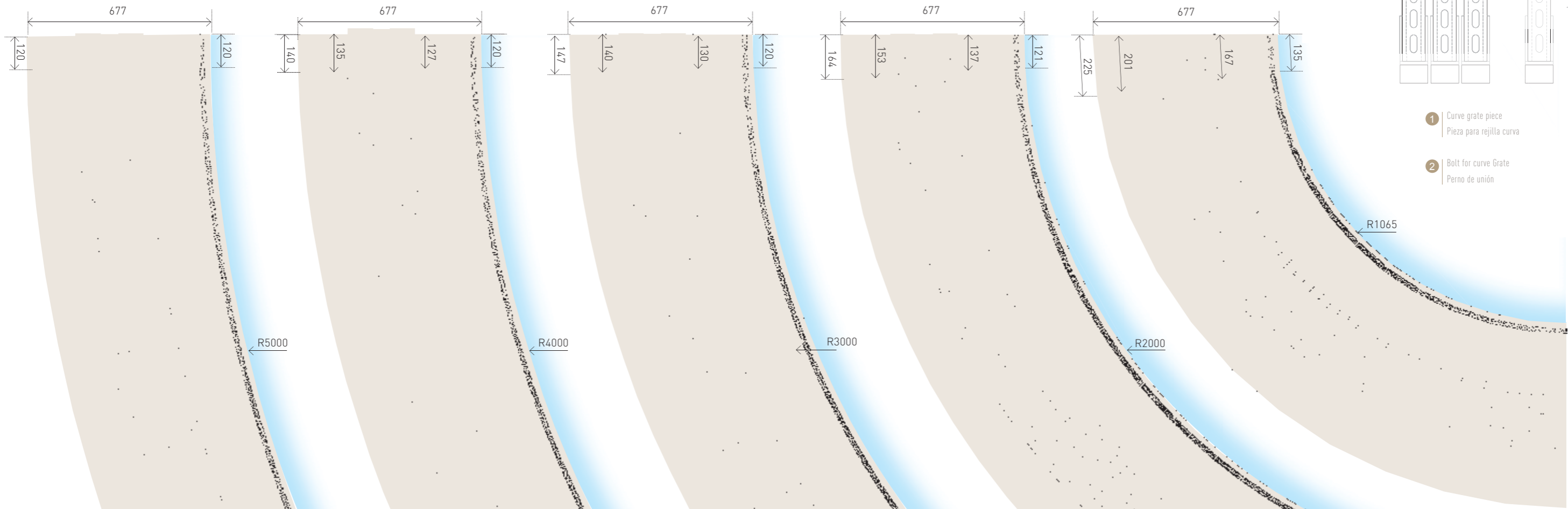

SAFETY POOLS
PISCINAS SEGURAS



Antislip
Antideslizante

Cerámica Mayor offers a super anti-slip finish R12 with a special engraving to maintain safety in the wet areas of terraces pools and spas. Helping to prevent falls and slips.

Cerámica Mayor ofrece un acabado súper antideslizante R12 con un grabado especial para mantener la seguridad en las zonas húmedas de terrazas, piscinas y spas. Ayudando a evitar caídas y resbalones.

R12 Super antislip
Súper antideslizante



UNE ENV 12633

Clase 3



DIN 51130

R12



DIN 51097

Clase C

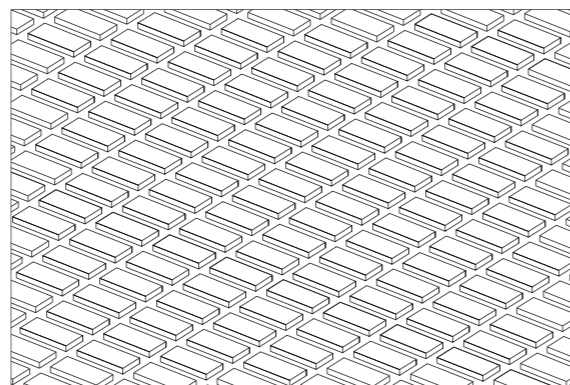

*Hawaii & Mikonos Pool Systems



Super antislip visual effect R12 - Efecto visual R12 súper antideslizante

PUBLIC POOLS SOLUTIONS
SEÑALIZACIÓN PARA PISCINAS PÚBLICAS

Public pools warning signaling
Señalización de advertencia para piscinas públicas



Number dimensions example

Ejemplo de las dimensiones de los números

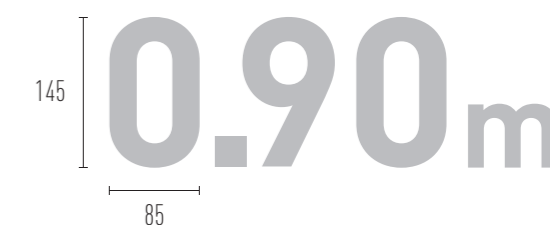

*Safety signs under demand

*Piezas de señalización bajo demanda

Warning pool symbols example

Ejemplo de señales de advertencia

DEEP FEET

80^{FT}



Brands
Marcas

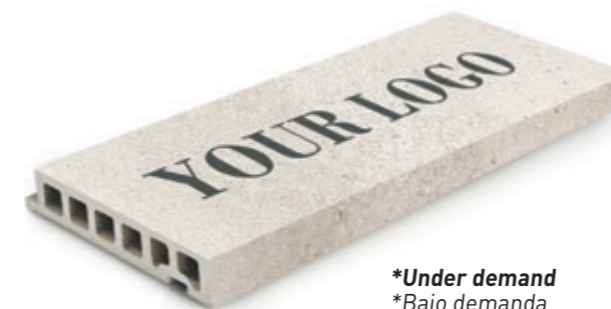

*Under demand
*Bajo demanda

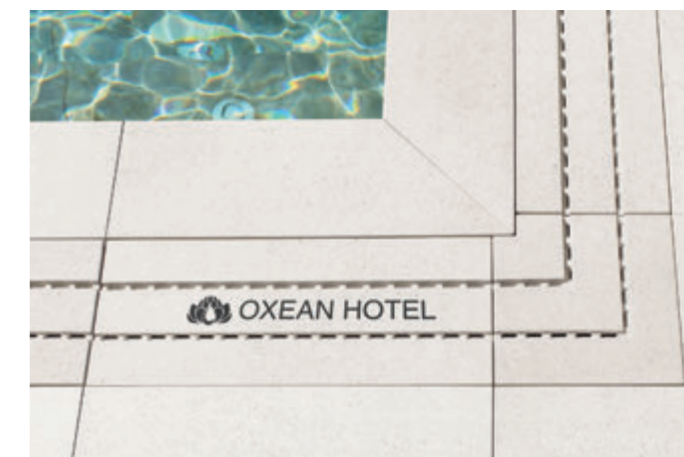

SUP PIEZA POOL CON TEXTO
Art. 7087 [M-492] extra cost 1pz

NEW SIZE 90x90

NON SLIP TERRACES
TERRAZA ANTIDESLIZANTE

NEW
COLLECTION



Mayör
60

RIVERSIDE_deep



SCALE 1:1

Riverside Serie

61

RIVERSIDE
BLUESTONE FROM NATURE

FLOOR PAVIMENTO

TILES



9x45 Rodapié
(M-744) pz

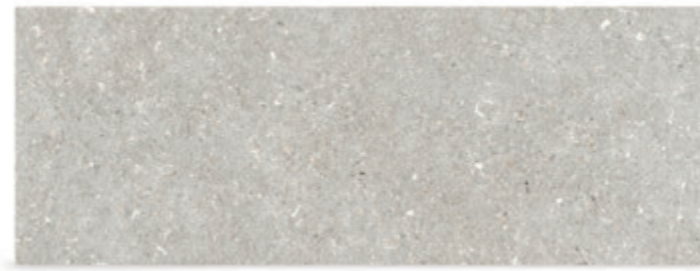

45x120^R Base
(M-713) m²



90x90^R Base
(M-722) m²

^(R) Rectified tiles - Bases rectificadas

STEP PELDAÑO

STEPS



120x33 Peldaño recto
MONOBLOCK
(M-739) pz



9x45 Zanquín recto
(Dcha./Izq.)
(M-743) 2 pzs



13,5x120 Tabica
(M-390) pz



PEARL

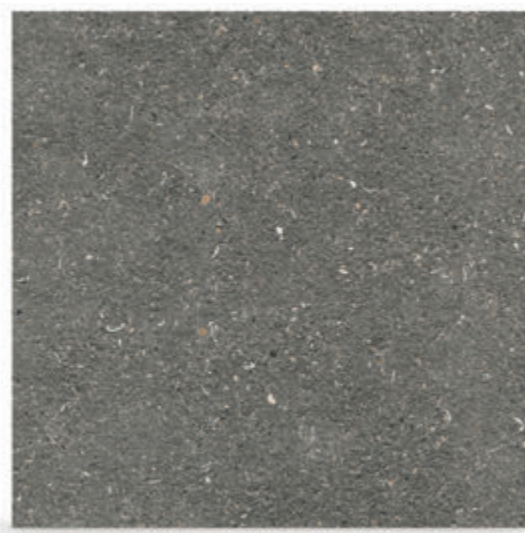

DEEP



RIVERSIDE_pearl

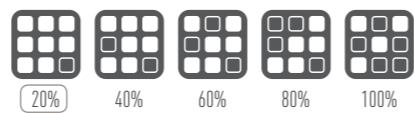



PEARL

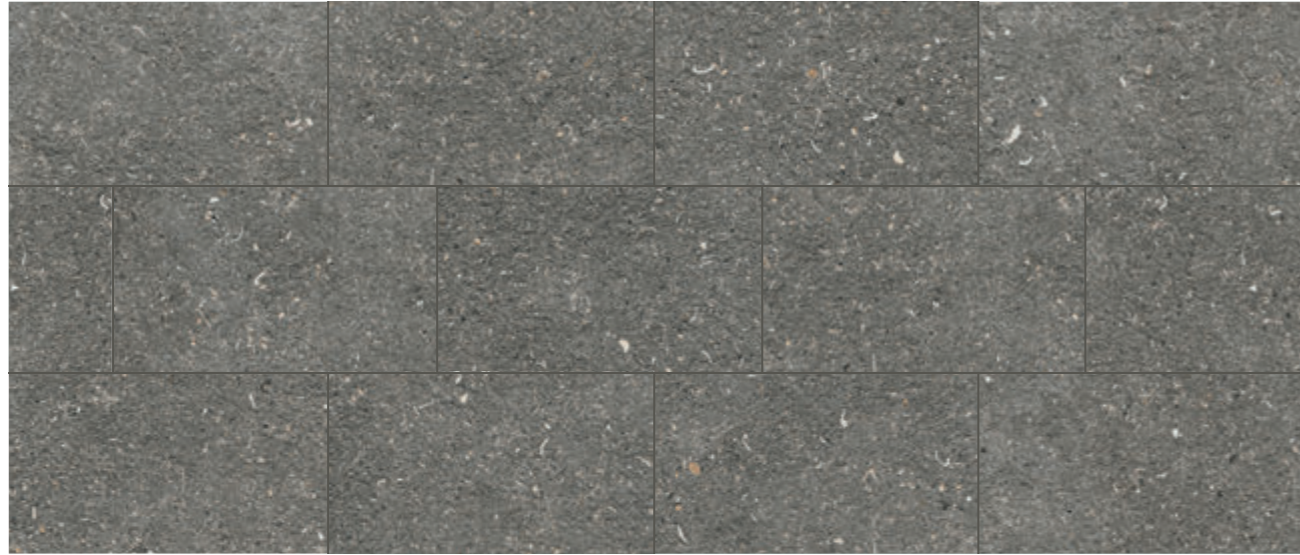

DEEP

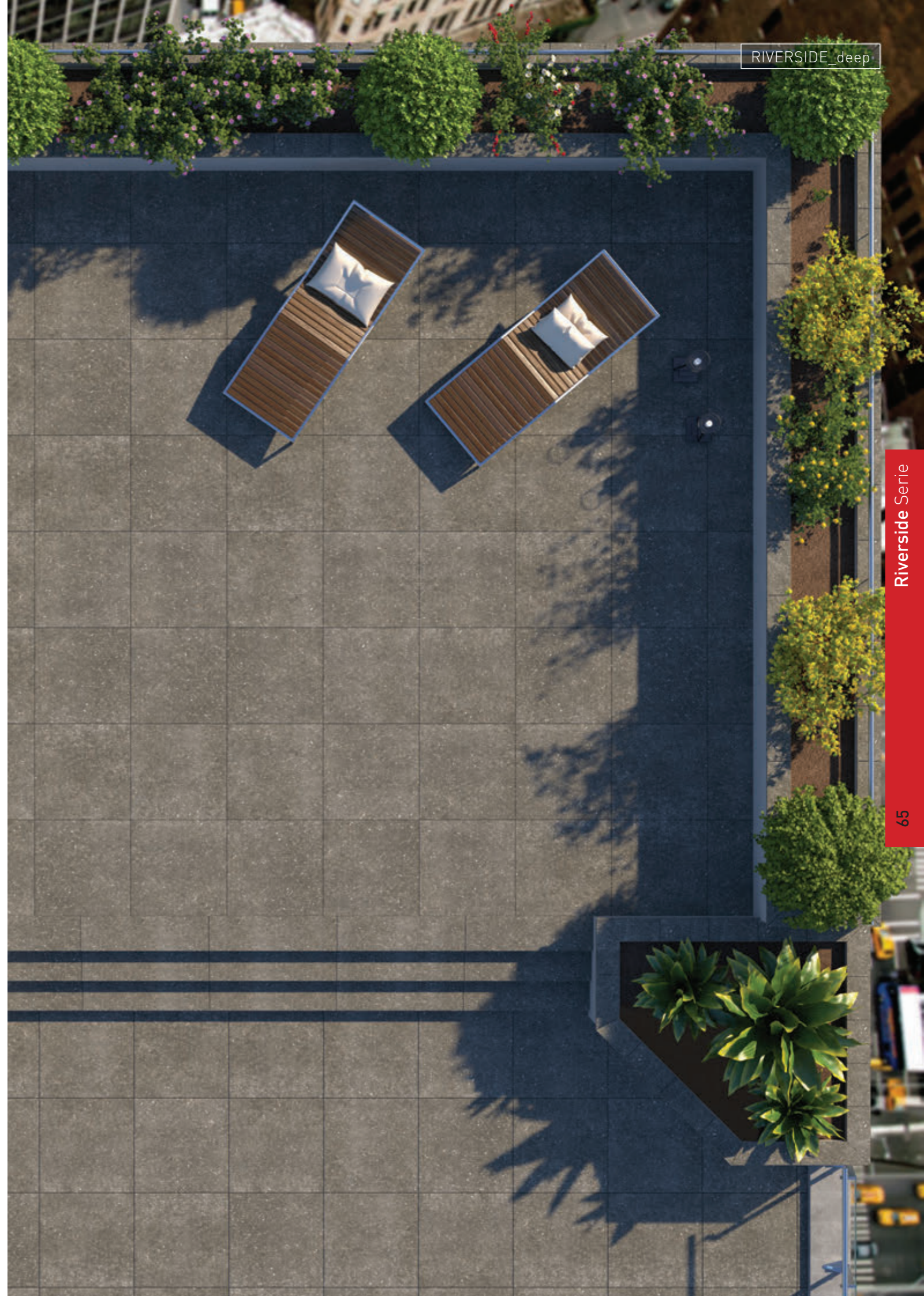

RIVERSIDE_deep



STROMBOLI_granit



SCALE 1:1

stromboli
natural modernity



LIGHT



CREAM

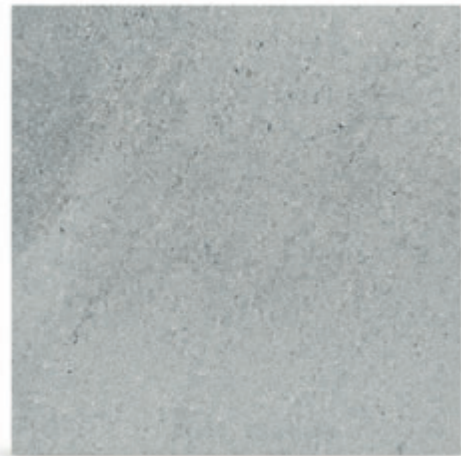

SILVER



GRANIT

FLOOR SOLUTIONS
SOLUCIONES PARA PAVIMENTO

TILES



31,6x31,6* Base
(M-494) m²

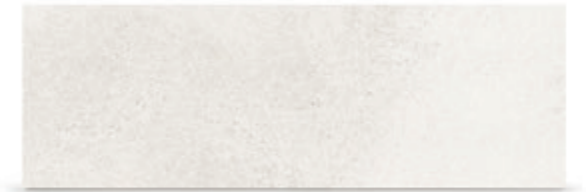

31x83* Base
(M-741) m²

Light
Cream
Silver

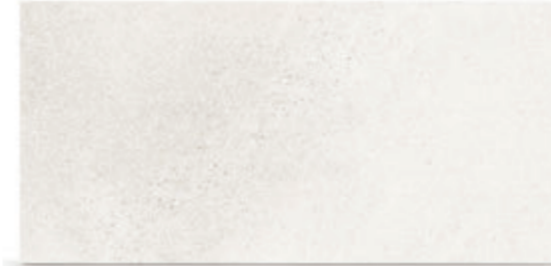

45x75^R Base
(M-711) m²

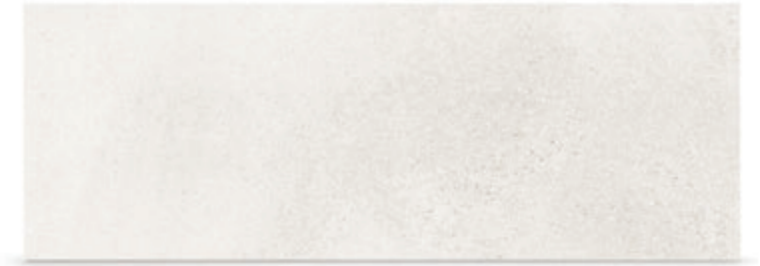

45x120^R Base
(M-713) m²

(*) Tiles without rectify - Bases sin rectificar | (R) Rectified tiles - Bases rectificadas

STEP SOLUTIONS
SOLUCIONES PARA PELDAÑO

STEPS AND SPECIAL PIECES



31,6x33 Peldaño recto
MONOBLOCK
(M-707) pz



33x33 Peldaño angular recto
MONOBLOCK
(M-715) pz



9x45 Zanquín recto
(Dcha. /Izq.)
(M-743) 2 pzs



120x33 Peldaño completo
MONOBLOCK
(M-419) pz



9x45 Zanquín completo
(Dcha. /Izq.)
(M-750) 2 pzs

OTHER FINISHES
OTROS ACABADOS

FINISHES



13,5x120 Tabica
(M-390) pz



9x45 Rodapié
(M-744) pz



18x50 Vierendeaguas
MONOBLOCK
(M-392) pz



LIGHT



CREAM



SILVER

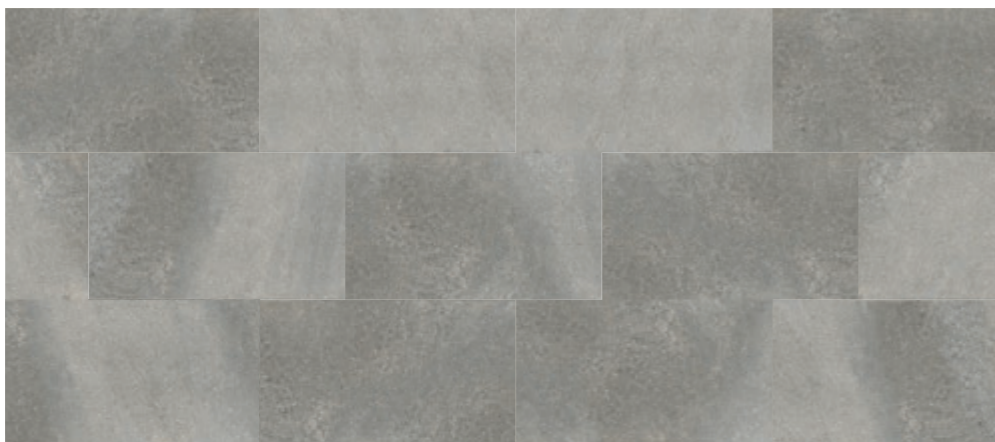

GRANIT





RAINFOREST_nogal



RAINFOREST
NATURAL ATMOSPHERE



BLANCO



MUSGO

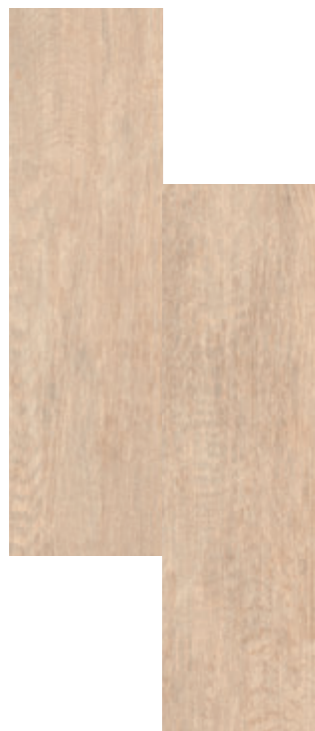

HAYA

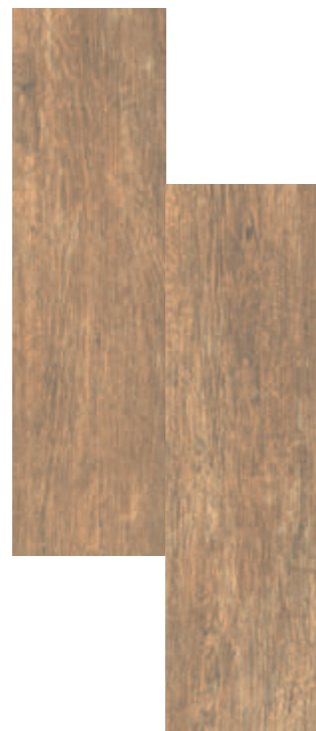

ROBLE



NOGAL

FLOOR TILES AND WALL / ANTI-SLIP / WOOD
PAVIMENTO Y REVESTIMIENTO / ANTIDESLIZANTE / MADERA

Aesthetic classification and shade variations
Clasificación estética y destonificación

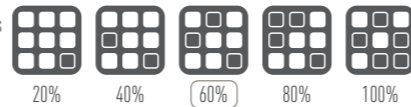

FLOOR SOLUTIONS SOLUCIONES PARA PAVIMENTO



22,5x75^R Base
(M-710) m²



20x83^{*} Base
(M-740) m²

Blanco
Musgo
Nogal



22,5x120^R Base
(M-712) m²

(*) Tiles without rectify - Bases sin rectificar | (R) Rectified tiles - Bases rectificadas

STEP SOLUTIONS SOLUCIONES PARA PELDAÑO



31,6x33 Peldaño recto
MONOBLOCK
(M-707) pz



33x33 Peldaño angular recto (Dcha. /Izq.)
MONOBLOCK
(M-715) pz



9x45 Zanquín recto
(Dcha. /Izq.)
(M-743) 2 pzs



31,6x33 Peldaño florentino
MONOBLOCK
(M-382) pz



33x33 Peldaño angular florentino (Dcha. /Izq.)
MONOBLOCK
(M-714) pz



9x45 Zanquín florentino
(Dcha. /Izq.)
(M-751) 2 pzs



120x33 Peldaño completo
MONOBLOCK
(M-419) pz



9x45 Zanquín completo
(Dcha. /Izq.)
(M-750) 2 pzs

OTHER FINISHES OTROS ACABADOS



9x45 Rodapié
(M-744) pz



13,5x120 Tabica
(M-390) pz



18x50 Vierteaguas
MONOBLOCK
(M-392) pz



BLANCO



MUSGO

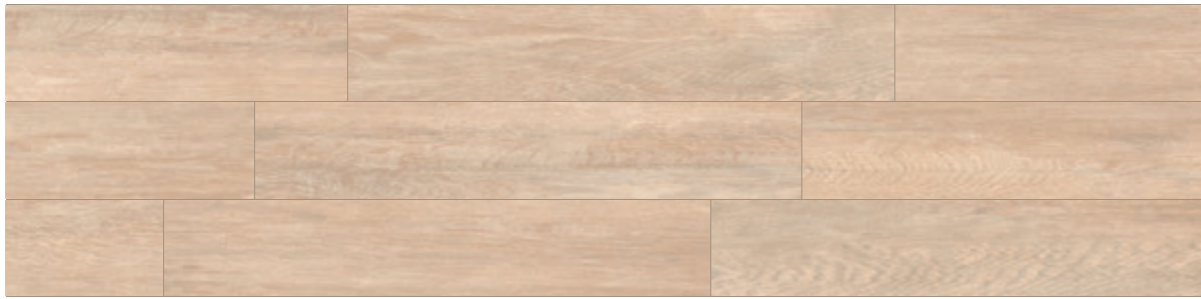

HAYA



ROBLE

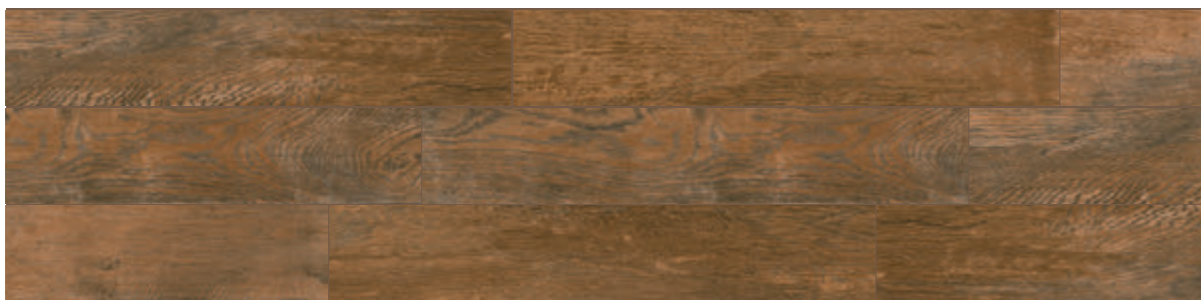

NOGAL



RAINFOREST_musgo



SEA ROCK_caramel



SCALE 1:1

Sea Rock
ELEGANCE AND WARMTH



MARFIL



CARAMEL

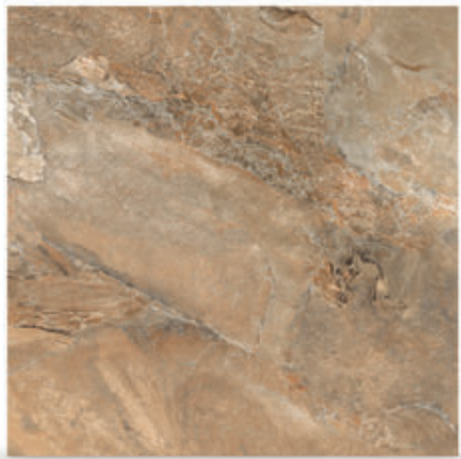

TOFFEE

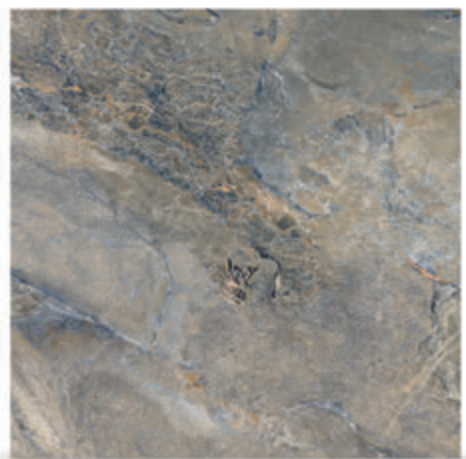

GRIS OSCURO

FLOOR SOLUTIONS SOLUCIONES PARA PAVIMENTO

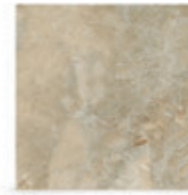

31,6x31,6* Base
(M-494) m²



45x75* Base
(M-711) m²



45x120* Base
(M-713) m²

(*) Tiles without rectify - Bases sin rectificar
(*) Rectified tiles - Bases rectificadas

STEPS SOLUTIONS SOLUCIONES PARA PELDAÑO



31,6x33 Peldaño recto
MONOBLOCK
(M-707) pz



33x33 Peldaño angular recto
MONOBLOCK
(M-715) pz



9x45 Zanquín recto
(Dcha. /Izq.)
(M-743) 2 pzs



31,6x33 Peldaño florentino
MONOBLOCK
(M-382) pz



33x33 Peldaño angular florentino
MONOBLOCK
(M-714) pz

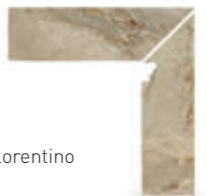

9x45 Zanquín florentino
(Dcha. /Izq.)
(M-751) 2 pzs



120x33 Peldaño completo
MONOBLOCK
(M-419) pz

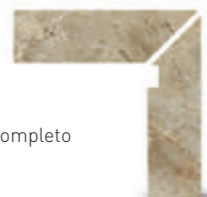

9x45 Zanquín completo
(Dcha. /Izq.)
(M-750) 2 pzs

OTHER FINISHES OTROS ACABADOS



9x45 Rodapié
(M-744) pz



13,5x120 Tabica
(M-390) pz



18x50 Vierteaguas
MONOBLOCK
(M-392) pz

FINISHES

STEPS AND SPECIAL PIECES

TILES



MARFIL



CARAMEL

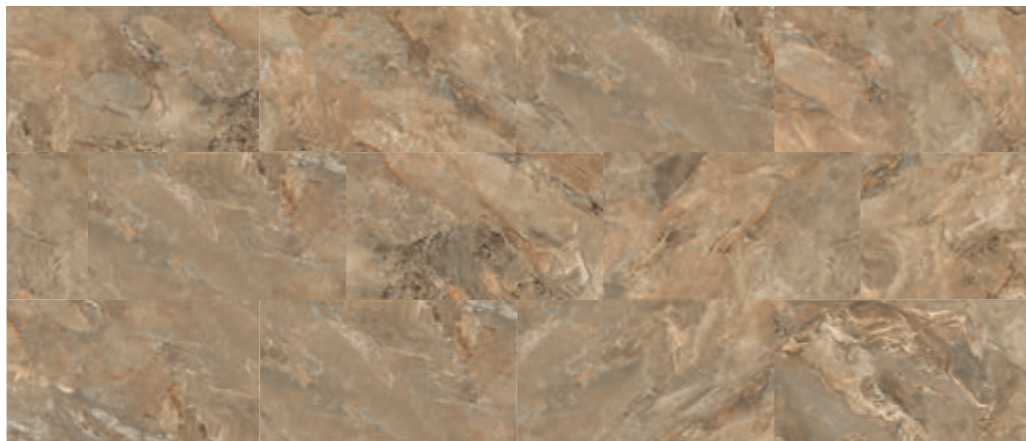

TOFFEE

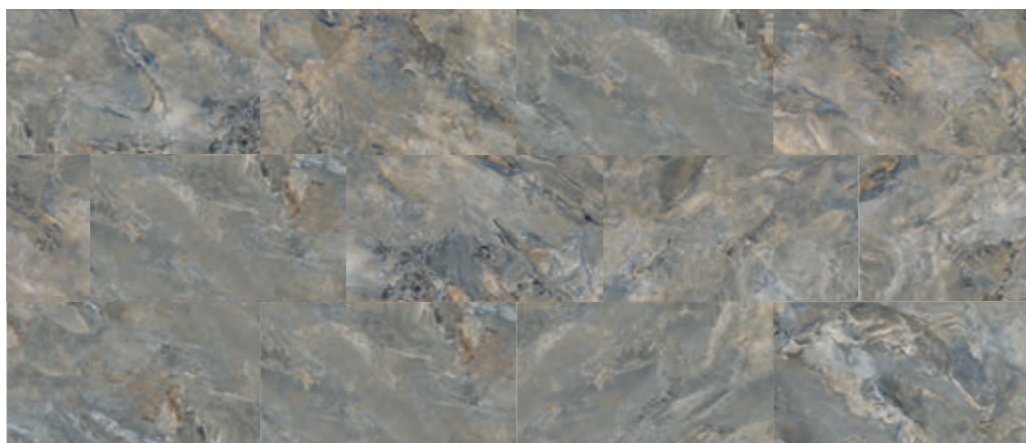

GRIS OSCURO





COLONIAL_cotto



SCALE 1:1

Colonial

COLOURS
OF THE
WORLD
series



COTTO



BRICK



COTTO

STEP SOLUTIONS SOLUCIONES PARA PELDAÑO

STEPS AND SPECIAL PIECES



31,6x33 Peldaño recto
MONOBLOCK
(M-707) pz



9x30 Zanquín recto
(Dcha./Izq.)
(M-706) 2 pzs

FLOOR SOLUTIONS SOLUCIONES PARA PAVIMENTO

TILES



31,6x31,6* Base
(M-494) m²
*Sin rectificar



9x31,6 Rodapié
(M-180) pz

OTHER FINISHES OTROS ACABADOS

FINISHES



18x31,6 Vierteaguas
MONOBLOCK
(M-702) pz



BRICK

STEP SOLUTIONS SOLUCIONES PARA PELDAÑO

STEPS AND SPECIAL PIECES



31,6x33 Peldaño florentino
MONOBLOCK
(M-382) pz



33x33 Peldaño angular florentino
(Dcha./Izq.)
MONOBLOCK
(M-714) pz



9x30 Zanquín recto
(Dcha./Izq.)
(M-706) 2 pzs

FLOOR SOLUTIONS SOLUCIONES PARA PAVIMENTO

TILES



31,6x31,6* Base
(M-494) m²
*Sin rectificar



9x31,6 Rodapié
(M-180) pz

(*) Tiles without rectify - Bases sin rectificar

FLOOR TILES AND WALL / ANTI-SLIP / RUSTIC
PAVIMENTO Y REVESTIMIENTO / ANTIDESLIZANTE / RUSTICO

Aesthetic classification and shade variations
Clasificación estética y destonificación

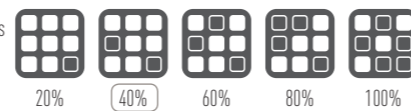

MONOBLOCK CERAMIC SPECIAL PIECES
PIEZAS ESPECIALES CERÁMICAS



CANYON_cal



SCALE 1:1

canyon



CAL

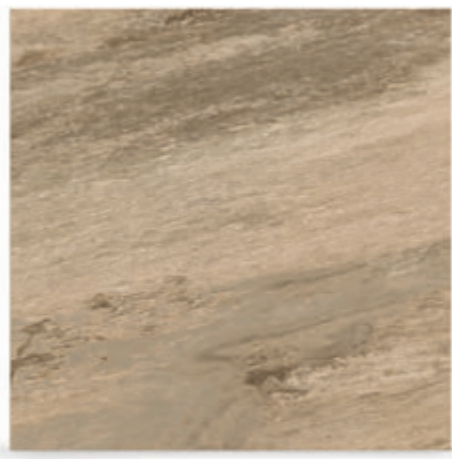

CREME

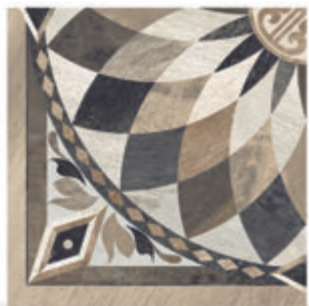

DECO

FLOOR SOLUTIONS
SOLUCIONES PARA PAVIMENTO

TILES



31,6x31,6* Base
(M-494) m²

OTHER FINISHES
OTROS ACABADOS

FINISHES



9x31,6 Rodapié
(M-180) pz

(*) Tiles without rectify - Bases sin rectificar

STEPS SOLUTIONS
SOLUCIONES PARA PELDAÑOS

STEPS AND SPECIAL PIECES



31,6x33 Peldaño florentino
MONOBLOCK
(M-382) pz



33x33 Peldaño angular florentino
MONOBLOCK
(M-714) pz



9x30 Zanquín florentino
(Dcha. /Izq.)
(M-705) 2 pzs

DECORATIVE PIECES AND COMPOSITION SAMPLES
PIEZAS Y EJEMPLOS DE COMPOSICIONES DECORATIVAS

FINISHES



31,6x31,6* Rosetón
Ref. ROCY 0002
4 PZAS/CAJA
(M-427) 4 PIEZAS



31,6x31,6* Rosetón
Ref. ROCY 0003
4 PZAS/CAJA
(M-427) 4 PIEZAS



31,6x31,6* Rosetón
Ref. ROCY 0004
4 PZAS/CAJA
(M-427) 4 PIEZAS



13,5x31,6 Tabica
Ref. TACY 0002
(M-701) pz

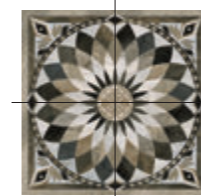

2x2 ROCY 0002: 4 pz



4x4 ROCY 0002: 4 pz
ROCY 0003: 8 pz
ROCY 0004: 4 pz



6x6 ROCY 0002: 8 pz
ROCY 0003: 16 pz
ROCY 0004: 12 pz





CAL



CREME





94 Maypor

Fossil Serie

95

FOSSIL_sand



SCALE 1:1

FOSSIL
natural & warm



SALT



SAND

FLOOR SOLUTIONS SOLUCIONES PARA PAVIMENTO

TILES



45x75^R Base
(M-711) m²



45x120^R Base
(M-713) m²

(^R) Rectified tiles - Bases rectificadas

STEP SOLUTIONS SOLUCIONES PARA PELDAÑO

STEPS AND SPECIAL PIECES



31,6x33 Peldaño florentino
MONOBLOCK (M-382) pz



33x33 Peldaño angular florentino [Dcha. /Izq.]
MONOBLOCK (M-714) pz



9x45 Zanquín florentino [Dcha. /Izq.]
(M-751) 2 pzs



120x33 Peldaño completo
MONOBLOCK (M-419) pz



9x45 Zanquín completo [Dcha. /Izq.]
(M-750) 2 pzs

OTHER FINISHES OTROS ACABADOS

FINISHES



9x45 Rodapié
(M-744) pz



13,5x120 Tabica
(M-390) pz



18x50 Vierteaguas
MONOBLOCK (M-392) pz



SALT



SAND



TIMES SQUARE
UNION SQUARE

100 Mayor



Materia Serie

101

MATERIA_bianco



SCALE 1:1

MATERIA
CONTEMPORARY



BIANCO



ARENA



PLOMO

FLOOR SOLUTIONS SOLUCIONES PARA PAVIMENTO



31,6x31,6* Base
(M-494) m²

(* Tiles without rectify - Bases sin rectificar)

STEP SOLUTIONS SOLUCIONES PARA PELDAÑO



31,6x33 Peldaño recto
MONOBLOCK
(M-707) pz



9x30 Zanquín recto
(Dcha. /Izq.)
(M-706) 2 pzs

OTHER FINISHES OTROS ACABADOS



9x31,6 Rodapié
(M-180) pz



18x31,6 Vierendeaguas
MONOBLOCK
(M-702) pz





BIANCO



ARENA



PLOMO



MATERIA_plomo

TECHNICAL CHARACTERISTICS CARACTERÍSTICAS TÉCNICAS

CONSTRUCTIVE SOLUTIONS SOLUCIONES CONSTRUCTIVAS



Technical information about our special pieces Información técnica de nuestras piezas especiales

Antideslizante Antislip | UNE ENV 12633 **Clase 3**

Antideslizante Antislip | DIN 51130 **R10 / R12***
*Hawaii & Mikonos

Antideslizante Antislip | DIN 51097 **Clase C**

Resistencia al impacto | Impact strenght | ✓

Resistencia a la helada | Frost resistance | ✓

Resistencia al choque térmico | Thermal shock resistance | ✓

Resistencia a las manchas | Stain resistance | **5**

Resistencia al rayado | Scratch resistance | **9**

Resistencia a la abrasión | Friction resistance | **IV - V**

Resistencia a la flexión | Bending strenght | **>23N / mm²**

Resistencia al fuego | Modulus of ruptura | ✓

Tolerancia dimensional | Dimensional tolerance | ✓

Porcelain tile
Gres porcelánico

MONOBLOCK

ONE PIECE WITHOUT GLUED

UNA PIEZA, SIN PEGADO



Ceramic grate solution for stairs Solución de rejilla para escaleras



Vierteaguas solution for terrace Solución de vierteaguas para terraza



MOUNTING

MONTAJE



Step fitting indications

Indicaciones para el montaje de peldaños

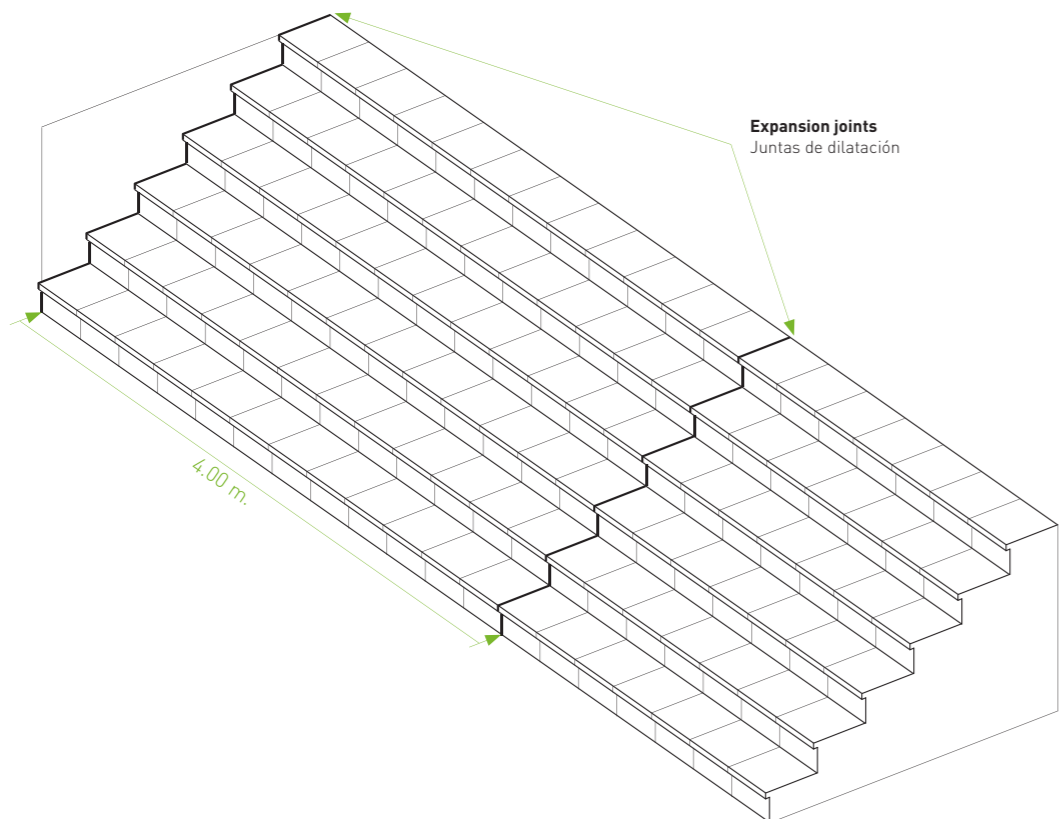
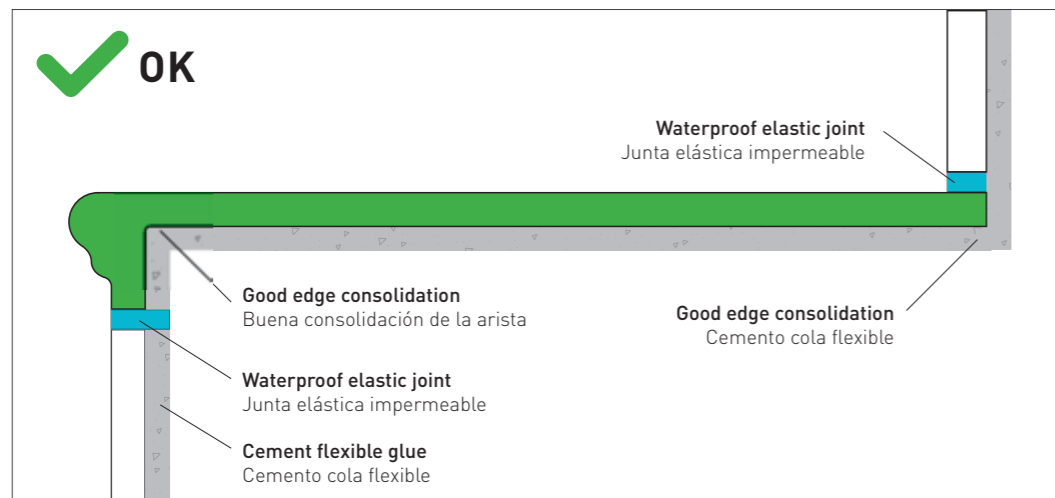

Tiles mounting recommendation

Recomendación de montaje para bases

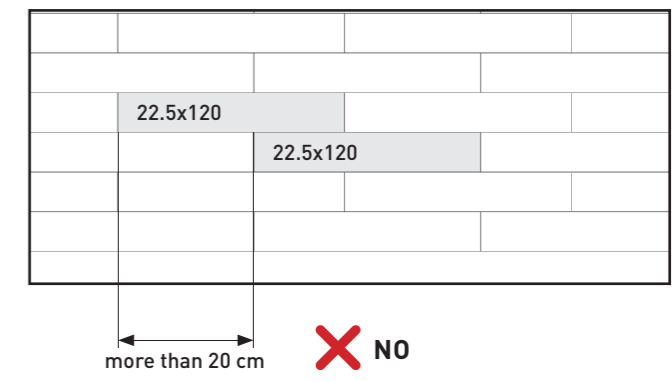
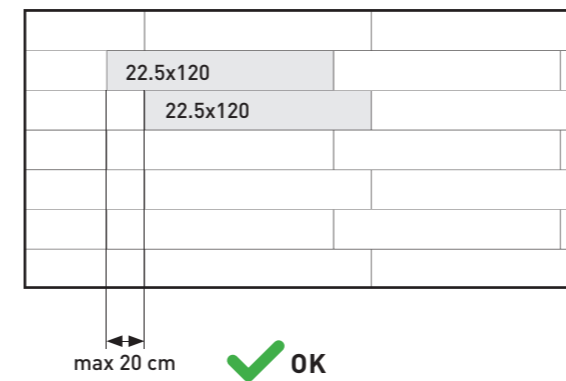
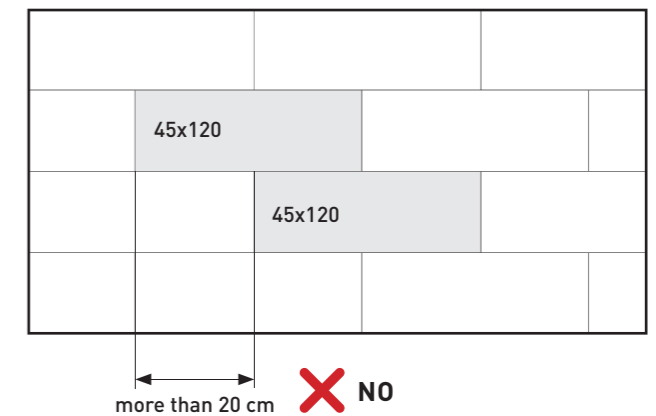
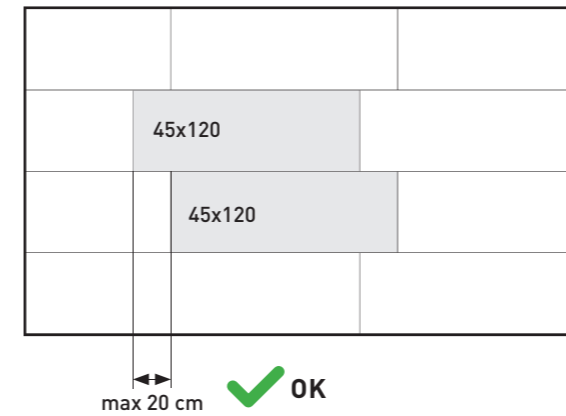

¡IMPORTANT NOTICE! BEFORE INSTALLING, NOTE THE FOLLOWING.

- Verify that the material being set is that which the customer ordered.
- Ensure that all boxes are one shade and one caliber.
- Ensure there are no gross physical defects (1st quality material).
- IT IS RECOMMENDED TO MIX PIECES FROM SEVERAL BOXES WHEN SETTING.
- Claims will not be accepted when the above conditions are not complied with after the material has been installed.

THE BOX REFERENCE WILL BE NECESSARY FOR ANY CLAIM

NOTICE TO INSTALLERS

- During the design and installation stages the provision of all types of joints (structural, perimeter, intermediate) should be considered. For technical reasons, tile installation without joints is not recommended, as this is the cause of multiple defects and pathologies.
- A minimum joint width of 4.0 mm. Is recommended for stretcher bond and herringbone bond tile installation. "It is recommended that ¾ brick bond is used when fixing for a more satisfactory finish".
- Please do not ever use any charcoal black grouts.
- Once the tiles have been laid out, it is highly recommended to eliminate any remains of cement or grout with a domestic acid cleaner especially designed for ceramic tiles, which should be mixed with 3 parts of water and 1 of cleaner, and this should impregnate the surface to be cleaned not more than 5 minutes, after that please wash it with enough clean water. Never use any cleaning products that may contain fluorhydric acid. To ensure that the domestic cleaner chosen will not damage the floor tile area, it is also advisable to do a test on a non installed spare tile.
- Claims will not be accepted when the above conditions are not followed.

¡AVISO IMPORTANTE! ANTES DE LA PUESTA EN OBRA.

- Verificar que la calidad que figura impresa en el embalaje se corresponde con la del material solicitado.
- Verificar que todas las cajas pertenecen a un único tono y calibre.
- Verificar la ausencia de defectos visibles (baldosas de 1ª calidad).
- SE REQUIERE, AL COLOCAR, MEZCLAR PIEZAS DE VARIAS CAJAS.
- No se admitirán reclamaciones de problemas derivados del incumplimiento de estas premisas cuando el material ya esté colocado.

PARA ATENDER CUALQUIER RECLAMACIÓN ES NECESARIA LA REFERENCIA DE LA CAJA.

AVISO A LOS COLOCADORES

- Deberán planificarse y ejecutarse correctamente todo tipo de juntas: estructurales, perimetrales, de dilatación, y de colocación. La colocación sin juntas es desaconsejable desde cualquier punto de vista técnico, pudiendo ser el origen de varias patologías.
- Para la colocación de baldosas cerámicas de forma trabada o en espiga se requiere una junta de colocación mínima de 4.0 mm. Para un mejor acabado recomendamos no trabar las piezas a más de ¼ de su dimensión.
- En ningún caso deberán utilizarse materiales de rejuntado que contengan "Negro de Humo" (juntas negras).
- Finalizada la puesta en obra se recomienda eliminar los restos de materiales de agarre y rejuntado con un desincrustante comercial diseñado expresamente para baldosas cerámicas, rebajado con tres partes de agua, permaneciendo en contacto con la superficie a limpiar no más de 5 minutos, y aclarando la superficie inmediatamente después con abundante agua. No utilizar nunca salfument ni otros productos de limpieza que pudieran contener ácido fluorhídrico. Para verificar que el limpiador escogido no dañará el pavimento se requiere hacer una prueba previa en una zona oculta o poco visible o en una baldosa sin instalar.
- No se admitirán reclamaciones de problemas derivados del incumplimiento de estas premisas.

COMPONENTS FOR POOLS AND TERRACES

COMPONENTES PARA PISCINAS Y TERRAZAS

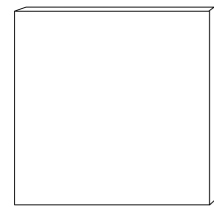

Base 31.6x31.6
 ▲ (*) 12.4x12.4 in. | 31.6x31.6 cm
 ⊕ 0.43 in. | 1.0 cm



Baseboard 9x31.6
 Rodapié 9x31.6
 ▲ 3.5x12.4 in. | 9x31.6 cm
 ⊕ 0.43 in. | 0.9 cm

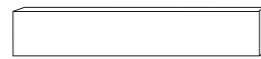

Baseboard 9x45
 Rodapié 9x45
 ▲ 3.5x17.72 in. | 9x45 cm
 ⊕ 0.43 in. | 0.9 cm

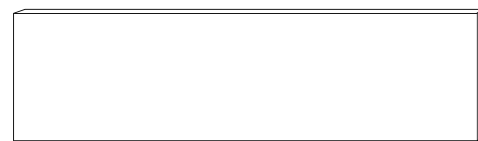

Base 22.5x75
 ▲ (*) 8.8x29.5 in. | 22.5x75 cm ⊕ 0.43 in. | 1.1 cm

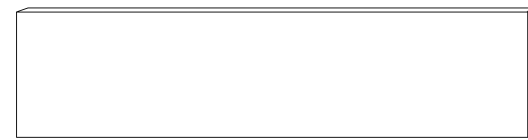

Base 20x83
 ▲ (*) 7.87x32.6 in. | 20x83 cm ⊕ 0.43 in. | 1.0 cm

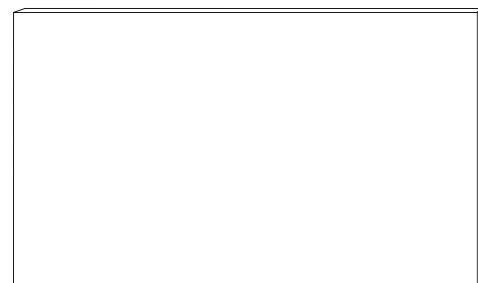

Base 45x75
 ▲ (*) 17.7x29.5 in. | 45x75 cm ⊕ 0.43 in. | 1.1 cm



Step Riser - Tabica
 ▲ 5.31x12.42 in. | 13.5x31.6 cm
 ⊕ 0.43 in. | 1.1 cm

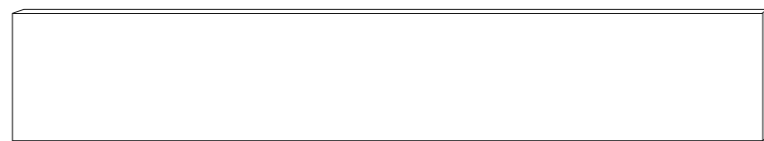

Base 22.5x120
 ▲ (*) 8.8x47.2 in. | 22.5x120 cm ⊕ 0.43 in. | 1.1 cm



Base 31x83
 ▲ (*) 12.2x32.6 in. | 31x83 cm
 ⊕ 0.43 in. | 1.0 cm

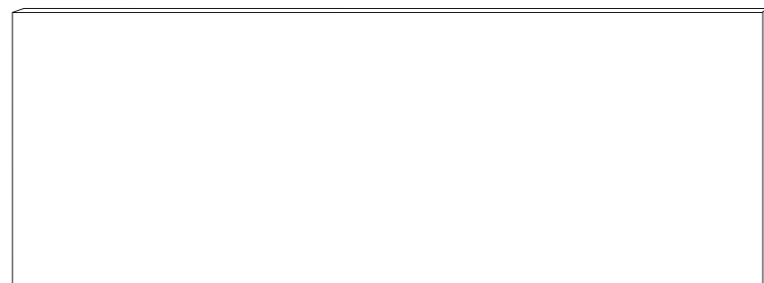

Base 45x120
 ▲ (*) 17.7x47.2 in. | 45x120 cm ⊕ 0.43 in. | 1.1 cm



Step Riser - Tabica
 ▲ 5.31x47.2 in. | 13.5x120 cm ⊕ 0.43 in. | 1.1 cm

(*) Tiles without rectify - Bases sin rectificar (R) Rectified tiles - Bases rectificadas

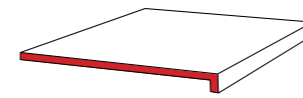

Recto Step
 Peldaño Recto
 ▲ 12.4x12.9 in. | 31.6x33 cm
 ⊕ 0.43 in. | 1.1 cm
 ⊖ 1.33 in. | 3.4 cm

+

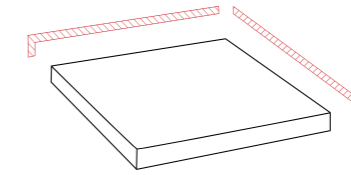

Angular Recto Step
 Peldaño Recto Angular
 ▲ 12.9x12.9 in. | 33x33 cm
 ⊕ 0.43 in. | 1.1 cm
 ⊖ 1.33 in. | 3.4 cm

+

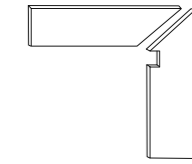

Zanquín Recto
 ▲ 3.5x11.8 in. | 9x30 cm
 ⊕ 0.43 in. | 0.9 cm
 ▲ 3.5x17.72 in. | 9x45 cm
 ⊕ 0.43 in. | 0.9 cm

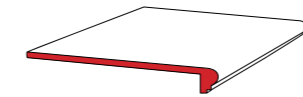

Florentino Step
 Peldaño Florentino
 ▲ 12.4x12.9 in. | 31.6x33 cm
 ⊕ 0.43 in. | 1.1 cm
 ⊖ 1.33 in. | 3.4 cm

+

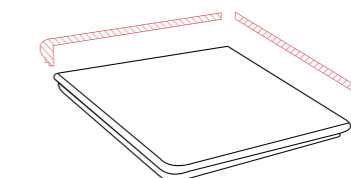

Angular Florentino Step
 Peldaño Angular Florentino
 ▲ 12.9x12.9 in. | 33x33 cm
 ⊕ 0.43 in. | 1.1 cm
 ⊖ 1.33 in. | 3.4 cm

+

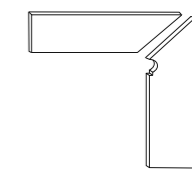

Zanquín Florentino
 ▲ 3.5x11.8 in. | 9x30 cm
 ⊕ 0.43 in. | 0.9 cm
 ▲ 3.5x17.72 in. | 9x45 cm
 ⊕ 0.43 in. | 0.9 cm



Complete Step
 Peldaño Completo
 ▲ 47.2x12.9 in. | 120x33 cm
 ⊖ 0.94 in. | 2.4 cm

+

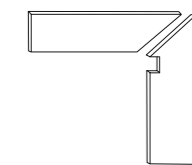

Zanquín Completo
 ▲ 3.5x11.8 in. | 9x30 cm
 ⊕ 0.43 in. | 0.9 cm
 ▲ 3.5x17.72 in. | 9x45 cm
 ⊕ 0.43 in. | 0.9 cm

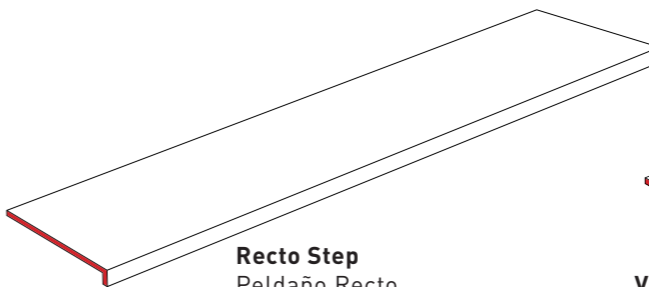

Recto Step
 Peldaño Recto
 ▲ 47.2x12.9 in. | 120x33 cm
 ⊕ 0.43 in. | 1.1 cm
 ⊖ 1.33 in. | 3.4 cm

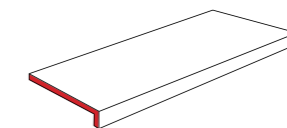

Vierteaguas 18x31.6
 ▲ 7.08x12.44 in. | 18x31.6 cm
 ⊕ 0.43 in. | 1.1 cm
 ⊖ 1.33 in. | 3.4 cm

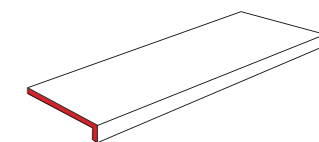

Vierteaguas 18x50
 ▲ 7.08x19.68 in. | 18x50 cm
 ⊕ 0.43 in. | 1.1 cm
 ⊖ 1.33 in. | 3.4 cm



PACKING & WORK DISPLAYS

PACKING Y HERRAMIENTAS DE TRABAJO

PROMOTIONAL MEDIA
SOPORTES PROMOCIONALES



anyplace



Visit our website for to download our brochures, technical information and quality certificates.

Visite nuestra página web para descargar nuestros catálogos, información técnica y certificados de calidad.

www.ceramicamayor.com



AVAILABLE COLOURS
COLORES DISPONIBLES

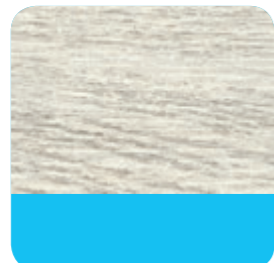

Rainforest BLANCO



Rainforest MUSGO



Sea Rock CAMEL



Stromboli LIGHT

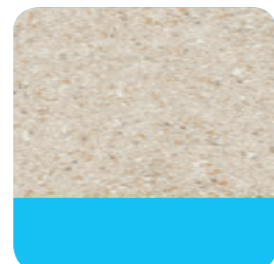

Stromboli CREAM



Stromboli SILVER



CM006

POOL SOLUTIONS FOLDER
CARPETA POOL SOLUTIONS

X: 335 mm
Y: 330 mm
Z: 45 mm

1 BOX

3,500 kgr.



CM008

POOL SERIES FOLDER
CARPETA SERIES PISCINA

X: 335 mm
Y: 330 mm
Z: 45 mm

1 BOX

3,500 kgr.



CM012

CANARIAS SYSTEM FOLDER
CARPETA SISTEMA CANARIAS

X: 335 mm
Y: 330 mm
Z: 45 mm

1 BOX

3,500 kgr.



PANEL

PM447 - HAWAII
PM448 - HAWAII CURVED
PM449 - MIKONONS
PM455 - CANARIAS

X: 1005 mm
Y: 1925 mm

1 BOX

DISPLAY
EXPOSITOR

EM010 - HAWAII
EM018 - MIKONONS
EM019 - CANARIAS

X: 700 mm
Y: 1600 mm
Z: 700 mm

1 BOX





FOLDERS
CARPETAS

- CM001 - SEA ROCK
- CM002 - RAINFOREST
- CM003 - FOSSIL
- CM004 - MATERIA
- CM005 - CANYON
- CM007 - STROMBOLI
- CM010 - COLONIAL

X: 335 mm
Y: 330 mm
Z: 45 mm

1 BOX 3,500 kgr.



PANEL

- PM435 - SEA ROCK
- PM436 - RAINFOREST
- PM441 - CANYON - FOSSIL
- PM443 - MATERIA
- PM442 - CANYON
- PM450 - CANYON DECO
- PM451 - STROMBOLI
- PM454 - COLONIAL

X: 1005 mm
Y: 1925 mm

1 BOX



DISPLAY
EXPOSITOR

- EM008 - SEA ROCK
- EM007 - RAINFOREST
- EM011 - FOSSIL
- EM016 - STROMBOLI

X: 700 mm
Y: 1600 mm
Z: 700 mm

1 BOX



STEP DISPLAY
EXPOSITOR PELDAÑO

- EM012 - STEPS SYSTEM - SISTEMA DE PELDAÑO
- EM001 - INDOOR - 10ud / INTERIOR - 10pz
- EM017 - OUTDOOR - 10ud / EXTERIOR - 10pz
- EM009 - BIG DISPLAY / GRANDE

X: 700 mm
Y: 1600 mm
Z: 700 mm

1 BOX



RESOURCES FOR PROJECTS
RECURSOS PARA PROYECTOS



Resolution of doubts or queries
Resolución de dudas o consultas

CERÁMICA MAYOR, S.A.
Partida Planet, s/n
03510 Callosa d'En Sarrià
(Alicante-España)

T +34 965 881 175
www.ceramicamayor.com



DESIGNERS. Resources for design
3D Pieces | Product pictures
Images of the collection's atmosphere

DISEÑADORES. Recursos para diseño
Piezas 3D | Fotos de producto
Imágenes de ambiente



ARCHITECTS. Department of aid for development projects
Resources used by architects

ARQUITECTOS. Departamento de ayuda para desarrollo de proyectos
Recursos para arquitectos

ABOUT THIS BROCHURE SOBRE ESTE CATÁLOGO

Technical characteristics of the tiles Características técnicas de la bases

Friction resistance Resistencia a la abrasión		EN ISO 10545-7	PEI IV - V
Frost resistance Resistencia a la helada		EN ISO 10545-12	✓
Thermal shock resistance Resistencia al choque térmico		EN ISO 10545-9	✓
Bending resistance Resistencia a la flexión		EN ISO 10545-4	>23N / mm²
Antislip Antideslizante		DESLIZAMIENTO	UNE ENV 12633 Clase 3
Antislip Antideslizante *Hawaii & Mikonos Pool Systems		Antislip Antideslizante	DIN 51130 R10 / R12*
Antislip Antideslizante		Antislip Antideslizante	DIN 51097 Clase C
Stain resistance Resistencia a las manchas		EN ISO 10545-14	5
Chemical resistance Resistencia química		EN ISO 10545-13	GA / GLA / GHA
Scratch resistance Resistencia al rayado		UNE 67101	9
Water absorption Absorción de agua		EN ISO 10545-3	< 0,5 %
Fire resistance Resistencia al fuego		CLASE A1 _{fl} Sin necesidad de ensayo (Decisión 96/603/ECC MODIFICADA)	✓
Impact resistance Resistencia al impacto		Breaking load Resistencia al impacto	✓
Dimensional tolerance Tolerancia dimensional		Dimensional tolerance Tolerancia dimensional	✓

* Mikonos & Hawaii Pool Systems | * Sistema de piscina Mikonos y Hawaii

Pool systems iconography Iconografía de los sistemas de piscina

	Noiseless Overflowing systems attenuate the surge and water shock inside the pool decreasing the noise.	Silencioso Los sistemas overflowing atenúan el oleaje y el choque del agua en el vaso de la piscina disminuyendo el ruido.
	Comfortable Our anti-slipping system R10 or R12, has a nice sensation to the touch. It allows you test the temperature of the water without having to dive inside.	Cómodo Nuestros sistemas antideslizantes R10 y R12 tienen una agradable sensación al tacto. Y permite probar la temperatura del agua sin necesidad de zambullirse dentro.
	Safety, without blind spots The overflowing system allows to see water surface. It is ideal for high traffic or children pools.	Seguro, sin puntos ciegos El sistema desbordante permite ver de manera continua toda la superficie del agua, es ideal para piscinas de alto tránsito o con niños.
	Pool chemical safety Material that does not stain or alter with the additives they put into the pool water for maintenance.	Resistente a químicos de piscina Material que no se mancha ni altera con los aditivos que se le ponen al agua de la piscina para su mantenimiento.
	Frost resistance Our low water-absorption pieces are resistant to frost.	Resistencia a la helada Nuestro sistema de piezas con baja absorción son resistentes a las heladas.
	Long life product Our pieces do not suffer deterioration or colour change with the pass of the time.	Producto de larga vida Nuestras piezas no sufren deterioro o cambio de color con el paso del tiempo.
	Easy maintenance Material easy to clean with hose or kartcher. Invest time in enjoying life.	Fácil mantenimiento Material de fácil limpieza con manguera o kartcher y invierte el tiempo en disfrutar.
	Integral aesthetics for pools and terraces A terrace with a single design and forget about having cutting areas between the terrace and pool.	Estética integral para piscinas y terraza Una terraza con un solo diseño 360° y olvídate de tener zonas de corte entre la terraza y la piscina.

Aesthetic classification and shade variations Clasificación estética y destonificación

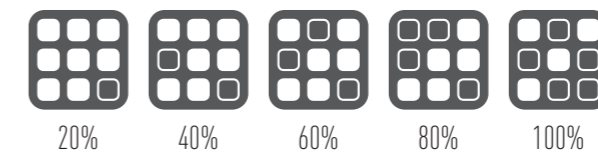

20% = Very Uniform Appearance. Pieces of the same shade value are very uniform and smooth in texture.

40% = Uniform Appearance. Differences among pieces from the same production run are minimal.

60% = Slight Variation. Clearly distinguishable differences in texture and/or pattern with similar colors.

80% = Moderate Variation. While the colors and/or texture present on a single piece of tile will be indicative of the colors and/or texture to be expected on the other tiles, the amount of colors and/or texture on each piece may vary significantly. It is recommended that the range be viewed before selection.

100% = Substantial Variation. Random color and/or texture differences from tile to tile, so that one tile may have totally different color and/or texture from that on other tiles. Thus, the final installation will be unique. It is recommended that the range be viewed before selection.

20% APARIENCIA MUY UNIFORME. Las piezas del mismo valor tonal son muy uniformes y de textura lisa.

40% APARIENCIA UNIFORME. Las diferencias entre las piezas de la misma producción son mínimas.

60% VARIACIÓN LIGERA. Las diferencias en textura y/o dibujos con colores son claramente diferenciadas.

80% VARIACIÓN MODERADA. Mientras que los colores y/o texturas presentes en una sola pieza serán indicativos de los colores y/o texturas en el resto de piezas, la cantidad de colores y/o texturas en cada pieza pueden variar significativamente. Es recomendable que se muestre toda la gama de colores antes de elegir.

100% VARIACIÓN SUBSTANCIAL. Color aleatorio y/o diferencias en textura de una pieza a otra, hasta el punto que una puede tener un color y/o textura diferentes del resto de piezas. Además, la instalación final será única. Se recomienda que se muestre toda la gama antes de elegir.

PIECES BY SERIES
PIEZAS POR SERIES

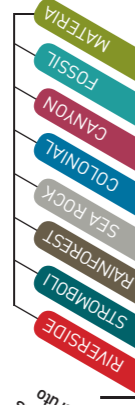

(*) Tiles without rectify - Bases sin rectificar
(*) Rectified tiles - Bases rectificadas

	precio	inches	piezas/caja	SOM/box	box/pallet	piezas/pallet	SOM/pallet	kg/box	kg/pallet gross	RIVERSIDE	STROMBOLI	RAINFREST	SEA ROCK	COLONIAL	CANYON	FOSSIL	MATERIA
BASE 31,6x31,6* cm	[M-494] m2	12.4"x12.4"	10	1,00	60	600	60	21,2	1.292	●			●				
BASE 22,5x75 ^R cm	[M-710] m2	8.86"x29.5"	6	1,0125	56	336	56,7	24,94	1.414,4		●						
BASE 22,5x120 ^R cm	[M-712] m2	8.86"x47.2"	4	1,08	64	252	69,12	26,91	1.742,24		●						
BASE 20x83* cm	[M-740] m2	7.87"x32.6"	6	0,996	60	360	59,76	21,782	1.323,68		●						
BASE 31x83* cm	[M-741] m2	12.2"x32.6"	4	1,0292	48	192	49,4	22,269	1.088,91		●						
BASE 45x75 ^R cm	[M-711] m2	17.7"x29.5"	3	1,012	56	168	56,67	24,36	1.445		●						
BASE 45x120 ^R cm	[M-713] m2	17.7"x47.2"	2	1,08	36	72	38,88	25,96	991		●						
BASE 90x90 ^R cm	[M-722] m2	35.4"x35.4"	1	-	-	-	-	-	-		●						
BASE DECO 31,6x31,6* cm	[M-427] 4 pz	12.4"x12.4"	4	0,4	120	480	46,4	5,52	1.010								●

PELDAÑO RECTO 31,6x33 cm	[M-707] pz	12.4"x12.9"	6	-	66	396	-	14,54	980		●						
PELDAÑO RECTO 120x33 cm	[M-739] pz	12.9"x47.2"	2	-	36	72	-	22,24	820,62		●						
PELDAÑO ANG. RECTO 33x33 cm	[M-715] pz	12.9"x12.9"	1	-	116	116	-	2,92	359		●						
PELDAÑO FLORENTINO 31,6x33 cm	[M-382] pz	12.4"x12.9"	6	-	66	396	-	15,35	1.033		●						
PELDAÑO ANG. FLORENTINO 33x33 cm	[M-714] pz	12.9"x12.9"	1	-	116	116	-	2,88	354		●						
PELDAÑO COMPLETO 120x33 cm	[M-419] pz	47.2"x12.9"	7	-	12	84	-	15,80/ud	1.346		●						
ZANQUÍN RECTO 9x30cm [D/I]	[M-706] 2 pz	3.5"x11.8"	11	-	99	1.089	-	10,69	1.078		●						
ZANQUÍN RECTO 9x45cm [D/I]	[M-743] 2 pz	3.5"x17.72"	11	-	56	616	-	19,08	1.088,48		●						
ZANQUÍN FLORENTINO 9x30cm [D/I]	[M-705] 2 pz	3.5"x11.8"	11	-	99	1.089	-	10,66	1.075,34		●						
ZANQUÍN FLORENTINO 9x45cm [D/I]	[M-751] 2 pz	3.5"x17.72"	11	-	56	616	-	19,03	1.085,68		●						
ZANQUÍN COMPLETO 9x30cm [D/I]	[M-340] 2 pz	3.5"x11.8"	11	-	99	1.089	-	11,93	1.201		●						
ZANQUÍN COMPLETO 9x45cm [D/I]	[M-750] 2 pz	3.5"x17.72"	11	-	56	616	-	19,08	1.088,48		●						

TERRACES

RODAPIÉ 9x31,6 cm	[M-180] pz	3.5"x12.4"	22	-	99	2.178	-	11,93	1.201		●						
RODAPIÉ 9x45 cm	[M-744] pz	3.5"x17.72"	22	-	56	1.232	-	21,3	1.212,8		●						
TABICA 13,5x120 cm	[M-390] pz	5.31"x47.2"	4	-	40	160	-	16,2	668		●						
TABICA 13,5x31,6 cm DECO	[M-701] pz	5.31"x12.42"	26	-	66	504	-	8,8	576		●						
VIERTAGUAS 18x31,6 cm	[M-702] pz	7.08"x12.44"	10	-	72	720	-	11,58	854		●						
VIERTAGUAS 18x50 cm	[M-392] pz	7.08"x19.68"	6	-	74	444	-	18,16	1.039		●						
VIERTAGUAS 18x50 CORTE Ref. VIER EE00 18x50 / VIER E100 18x50	[M-735] 2pz	-	-	-	-	-	-	-	-		●						

BORDE HAWAII - Ref. BPHA 0000 25x50	[M-709] pz	10"x20"	2	-	42	84	-	11,11	486,62		●						
BORDE HAWAII PACK ESQUINA Ref. BPHA EE00 25x50 / BPHA E100 25x50	[M-734] 2 pz	9.8"x19.6"	1 set	-	-	-	-	-	-		●						
BORDE CURVO HAWAII - Ref. BPHA RADIO	[M-414] pz	-	/radio	-	-	-	-	-	-		●						
REJILLA CERÁMICA RJ88 - Ref. RJ88 0000	[M-516] pz	10"x20"	2	-	42	84	-	8,91	394,22		●						
REJILLA CER. RJ88 ESQUINA - Ref. RJ88 E000 25	[M-719] pz	10"x10"	1	-	152	152	-	2,9	460		●						
REJILLA CER. RJ88 CURVA - Ref. RJ88 R101 25	[M-583] 11 pz	10"x20"	2	-	42	84	-	8,96	396,32		●						
SOPORTE HAWAII P/REJILLA - Ref. SRHA 0000 18x50	[M-716] pz	7"x19.5"	2	-	56	112	-	9,6	557,6		●						
SOPORTE HAWAII ESQUINA P/REJILLA Ref. SRHA EE00 18x50 / SRHA E100 18x50	[M-520] 2 pz	7.08"x19.6"	1 set	-	-	-	-	-	-		●						
SOPORTE HAWAII P/REJILLA CURVA Ref. SRHA RE00 / SRHA R100	[M-717] pz	-	/radio	-	-	-	-	-	-		●						

BORDE MIKONOS 2 CARAS Ref. BPMI 0000 E2C 45x70	[M-517] pz	17.7"x27.5"	2	-	22	44	-	15,05/ud	682		●						
PACK ESQUINA BORDE MIKONOS E2C Ref. BPMI EE00 E2C 45x70 / BPMI E100 E2C 45x70	[M-567] pz	17.7"x27.5"	1 set	-	-	-	-	-	-		●						
BORDE MIKONOS 2 CARAS AGUJERO SKIMMER Ref. BPMI SK00 E2C 45x70	[M-530] pz	17.7"x27.5"	-	-	-	-	-	-	-		●						
BORDE MIKONOS 2 CARAS CURVO Ref. BPMI RE00 E2C 45X_ / BPMI R100 E2C 45X_	[M-737] pz	-	/radio	-	-	-	-	-	-		●						
BORDE MIKONOS 3 CARAS Ref. BPMI 0000 E3C 45x70	[M-525] pz	17.7"x27.5"	2	-	22	44	-	15,05/ud	682		●						
BORDE MIKONOS 3 CARAS PACK ESQUINA Ref. BPMI EE00 E3C 45x70 / BPMI E100 E3C 45x70	[M-579] 2 pz	17.7"x27.5"	-	-	-	-	-	-	-		●						
BORDE MIKONOS 3 CARAS AGUJERO SKIMMER Ref. BPMI SK00 E3C 45x70	[M-736] pz	17.7"x27.5"	1 set	-	-	-	-	-	-		●						
BORDE MIKONOS 3 CARAS CURVO Ref. BPMI RE00 E3C 45X_ / BPMI R100 E3C 45X_	[M-738] pz	-	/radio	-	-	-	-	-	-		●						

BORDE SOPORTE CANARIAS - Ref. BSCA 0000 18x50	[M-729] pz	7.08"x19.6"	2	-	56	112	-	9,32/ud	541,92		●						
PACK ESQUINA BORDE SOPORTE CANARIAS Ref. BSCA EE00 18x50 / BSCA E100 18x50	[M-733] 2 pz	7.08"x19.6"	1 set	-	-	-	-	-	-		●						
BORDE SOPORTE CANARIAS CURVO Ref. BSCA RE00 / BSCA R100	[M-745] 2 pz	-	/radio	-	-	-	-	-	-		●						
REJILLA CERÁMICA RJ70 - Ref. RJ70 0000 20x50	[M-731] pz	7.08"x19.6"	2	-	56	112	-	6,65/ud	392,4		●						
REJILLA CER. RJ70 ESQUINA - Ref. RJ70 E000 20x20	[M-732] pz	9"x9"	1	-	152	152	-	-	-		●						
BORDE MAUI - Ref. BPMA 0000 33x50	[M-746] pz	12.9"x20"	2	-	36	72	-	13,22	495,92		●						
BORDE MAUI PACK ESQUINA Ref. BPMA EE00 33x50 / BPMA E100 33x50	[M-748] pz	-	1 set	-	-	-	-	-	-		●						
REJILLA CERÁMICA RJ66 - Ref. RJ66 0000	[M-747] pz	10"x20"	2	-	42	84	-	9,52	419,84		●						
REJILLA CER. RJ66 PACK ESQUINA - Ref. RJ66 E000	[M-749] pz	-	1 set	-	-	-	-	-	-		●						

PERNO REJILLA CURVA - Ref. 6493	[M-704] bolsa	-	25 bolsa	-	-	-	-	-	-		●						
GOMA PLANA REJILLA PISCINA - Ref. 6491	[M-250] metro	-	-	-	-	-	-	-	-		●						
SUP. PIEZA POOL CON TEXTO	[M-492] pz	-	-	-	-	-	-	-	-		●						
COSTE EXTRA CURVA ESPECIAL - Ref. 6624	[M-600] Unidad	-	-	-	-	-	-	-	-		●						

Componentes
ESPECIALES

Colours: LIGHT-CREME - SILVER
Colours: MUSGO - BLANCO
Colours: CARAMEL

Weights may suffer variations | Los pesos pueden sufrir variaciones

tempio®

SUSTAINABLE ARCHITECTURE FOR AN EFFICIENT FUTURE
ARQUITECTURA SOSTENIBLE PARA UN FUTURO EFICIENTE



MORE INFORMATION ABOUT
OUR SYSTEMS & AVANTAGES

MÁS INFORMACIÓN SOBRE
SISTEMAS Y BENEFICIOS

www.tempio.es

MORE INFORMATION
MÁS INFORMACIÓN

www.ceramicamayor.com

Mayor
CERÁMICA

CERÁMICA MAYOR, S.A.
Partida Planet, s/n
03510 Callosa d'En Sarrià
(Alicante-España)

T+34 965 881 175
www.ceramicamayor.com

Mayor
CERÁMICA

CERÁMICA MAYOR, S.A.
Partida Planet, s/n
03510 Callosa d'En Sarrià
(Alicante-España)

T+34 965 881 175
www.ceramicamayor.com

EDITION JAN'17

